



TDR-2000
Two-Wire Guided Wave Radar
Installation & Operation Manual



TDR-2000 Two-Wire Guided Wave Radar Installation & Operation Manual

CONTENTS

- I. HANDLING & STORAGE.....1
 - Inspection and Handling
 - Disposal and Recycling
 - Storage
- II. GENERAL SAFETY.....2
 - Authorized Personnel
 - Use
 - Misuse
- III. SPECIAL CONDITIONS FOR SAFE USE.....2
 - Aluminum Version
 - Window Version
- IV. ESSENTIAL HEALTH AND SAFETY REQUIREMENTS.....3
- V. PRODUCT DESCRIPTION3
 - Function
 - Applications
 - Features
 - Technical Specifications
 - Approvals
- VI. MECHANICAL INSTALLATION7
 - General Installations
 - Installation of Multiple Devices
 - Probe Alignment
- VII. ELECTRICAL INSTALLATION..... 11
 - General Safety
 - Disconnect Requirements for Permanently Installed Equipment
 - Conduit Cable Connection
 - Power Supply Requirements
 - Wiring TDR-2000 to Power Supply
 - Figure 1: Basic 24V Wiring - TDR-2000 to Power Supply
 - Figure 2. TDR-2000 to ORB Wiring Diagram
- VIII. SET-UP 15
 - Programming
 - Figure 3: Measurement Set-Up Guide
- IX. MAINTENANCE 19
- X. TROUBLESHOOTING 20

SAFETY SYMBOLS



WARNING:

IDENTIFIES CONDITIONS OR PROCEDURES, WHICH IF NOT FOLLOWED, COULD RESULT IN SERIOUS INJURY. RISK OF ELECTRICAL SHOCK.



CAUTION:

IDENTIFIES CONDITIONS OR PROCEDURES, WHICH IF NOT FOLLOWED, COULD RESULT IN SERIOUS DAMAGE OR FAILURE OF THE EQUIPMENT.

TDR-2000 Two-Wire Guided Wire Radar

I. HANDLING AND STORAGE

SAVE THESE INSTRUCTIONS

INSPECTION AND HANDLING

Do not dispose of the carton or packing materials.

Each package should be inspected upon receipt for damage that may have occurred due to mishandling during shipping. If the unit is received damaged, notify the carrier or the factory for instructions. Failure to do so may void your warranty. If you have any problems or questions, consult Customer Support at 1-800-778-9242.

DISPOSAL AND RECYCLING

This product can be recycled by specialized companies and must not be disposed of in a municipal collection site. If you do not have the means to dispose of properly, please contact Bindicator for return and disposal instructions or options.

STORAGE

If the device is not scheduled for immediate installation following delivery, the following steps should be observed:

1. Following inspection, repackage the unit into its original packaging.
2. Select a clean dry site, free of vibration, shock and impact hazards.
3. If storage will be extended longer than 30 days, the unit must be stored at temperatures between -40° and 176° F (-40° to 80° C) in non-condensing atmosphere with humidity less than 85%.



CAUTION: DO NOT STORE A NON-POWERED UNIT OUTDOORS FOR A PROLONGED PERIOD.

II. GENERAL SAFETY

AUTHORIZED PERSONNEL

All instructions described in the document must be performed by authorized and qualified service personnel only. Before installing the unit, please read these instructions and familiarize yourself with the requirements and functions of the device. The required personal protective equipment must always be worn when servicing this device.

USE

The device is solely intended for use as described in this manual. Reliable operation is ensured only if the instrument is used according to the specifications described in this document. For safety and warranty reasons, use of accessory equipment not recommended by the manufacturer or modification of this device is explicitly forbidden. All servicing of this equipment must be performed by qualified service personnel only. This device should be mounted in locations where it will not be subject to tampering by unauthorized personnel.

MISUSE

Improper use or installation of this device may cause the following:



- Personal injury or harm
- Application specific hazards such as vessel overfill
- Damage to the device or system

SAFETY REGULATIONS FOR THE EX APPROVED UNITS

The level transmitter must be operated in intrinsically safe circuit only. The metal enclosure of the unit must be connected to the EP circuit.

If any questions or problems arise during installation of this equipment, please contact the Customer Support at 800-778-9242.

III. SPECIAL CONDITIONS FOR SAFE USE

In case of the  II 1 G Ex ia IIC T6...T4 Ga and  II 1 G Ex ia IIB T6...T4 protected equipment version with aluminum enclosure, the aluminum-content of enclosure exceeds the limit, thus the equipment must be protected against impact and friction effects.

In case of the  II 1 G Ex ia IIC T6...T4 Ga,  II 1 G Ex ia IIIC T85°C...T110°C Da, protected equipment versions with window, the size of window exceeds the limit, thus the equipment must be protected against effects which results electrostatic charges.

IV. ESSENTIAL HEALTH AND SAFETY REQUIREMENTS

Covered by the standards fulfillment and the respect of the instructions for use.

V. PRODUCT DESCRIPTION

FUNCTION

The TDR-2000 two-wire guided microwave level transmitter uses the TDR (Time Domain Reflectometry) principle. The instrument sends low power nanosecond-wide pulses along an electrically conductive cable probe with a known propagation speed (the speed of light). As the pulse reaches the surface of the medium or phase of two liquids (altered dielectric constant ϵ_r), a part of it is reflected back to the electronic module. The efficiency of the reflected signal depends on the dielectric constant ϵ_r difference of the mediums or layers. The reflected pulse is detected as an electrical voltage signal and processed by the electronics. Level distance is directly proportional to the flight time of the pulse. The measured level data is converted into 4-20 mA current is displayed on the LCD display. From the level data, further derived measuring values can be calculated such as volume and mass. The TDR technology is unaffected by the other properties of the medium as well as that of the space above it.

APPLICATIONS

Designed for measuring the distance, level, volume of liquids, pastes, slurries and powder products; applicable in tanks, silos, rigid pipe, reaction vessel and level reference vessel.

FEATURES

- Insensitive to changes in dielectric, pressure, conductivity, vacuum, humidity, dust, viscosity, vapor, foam, pH, bulk density, temperature, or turbulence
- Unaffected by filling or emptying conditions such as dust, noise, and material movement
- Simple to install in new tanks or retrofit existing tanks
- Can be installed while tank is in service
- Does not require special configuration to compensate for environmental or structural conditions
- Factory calibrated and configured
- Transmitter design minimizes maintenance requirements

HOW TO ORDER

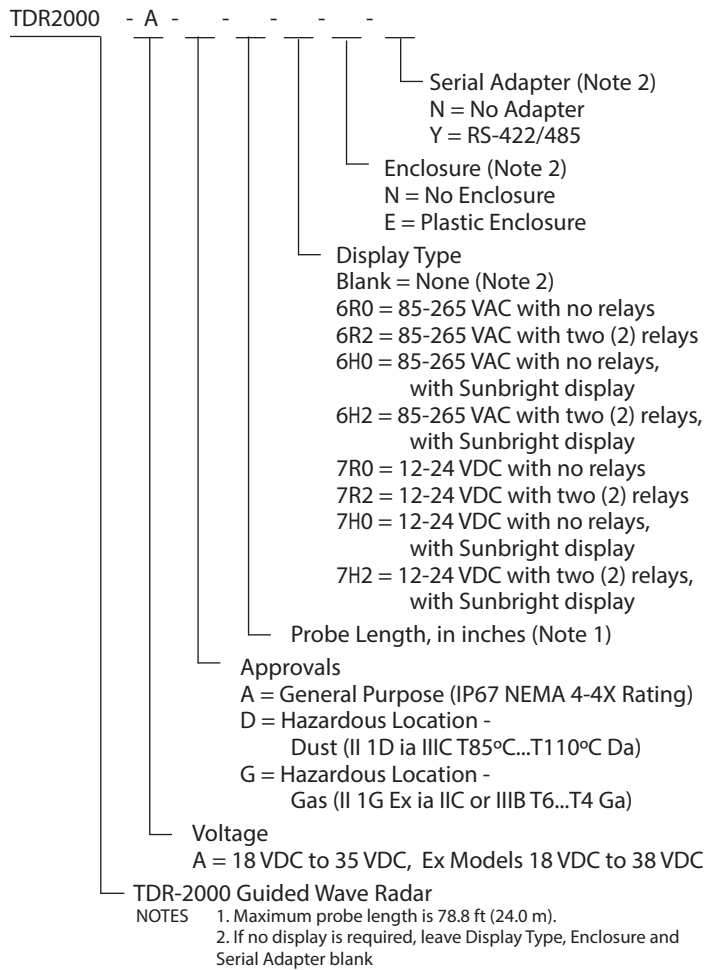

TECHNICAL SPECIFICATIONS

FUNCTIONAL	
Operating Power	24 VDC (18 to 35 VDC) Ex Version: 24 VDC (18 to 28 VDC)
Ambient Temperature	-4° to 140° F (-20° to 60° C)
Process Temperature	-22° to 212° F (-30° to 100° C) See Temperature Data Table p. 6 Flange: -22° to 194° F (-30° to 90° C)
Operating Pressure	580 psig (40 bar) See Pressure Diagram p. 6
Accuracy	Cable length < 33 ft (10 m); accuracy is ± 0.8" (20 mm)
	Cable length > 33 ft (10 m); accuracy is ± 0.20% of length
Dielectric Constant	> 2.1
Output	4-20 mA, HART Communication, terminal resistor 750 Ohm max
PERFORMANCE	
Measuring Range	Maximum of 79 ft (24.0 m)
	Deadband Top: 15.8" (40 cm) if $\epsilon_r < 10$; 11.8" (30 cm) if $\epsilon_r > 10$
	Deadband Bottom: 14.2" (36 cm)
	Counter Weight Diameter: 1.6" (4 cm); length 10.2" (26 cm)
PHYSICAL	
Process Connection	1 1/2" MNPT
Ingress Protection	IP67 (NEMA 4-4X)
Conduit Connections	(2) M20 x 1.5 and (2) 1/2" NPT
Electrical Protection	Class III
Probe Materials	Flexible 316 Stainless Steel Cable
Enclosure Materials	Aluminum with white epoxy coating
Gasket Materials	FPM (Viton®), FFKM Perfluoroelastomer (Kalrez® 6375), EPDM
Shipping Weight (Head Unit)	3.3 lb (1.5 kg)

APPROVALS

ATEX MARKINGS

- II 1G Ex ia IIB T6...T4 Ga
- II 1G Ex ia IIC T6...T4 Ga
- II 1D Ex ia IIIC T85°C... T110°C Da



T ambient = -20°C...+60°C

PER THE FOLLOWING STANDARDS:

- MSZ EN 60079-0:2013
- MSZ EN 60079-0:2013/A11:2014
- MSZ EN 60079-11:2012



SPECIAL DATA FOR EX CERTIFIED MODELS

Ex marking (ATEX)	II 1 G Ex ia IIC T6...T4 GA
	II 1 G Ex ia IIB T6...T4 GA
	II 1 D Ex ia IIIC T85°C...T110°C DA
Intrinsically safe data (Ex ia IIB and Ex ia IIIC)	$C_i \leq 10 \text{ nF}$, $L_i \leq 10 \text{ mH}$, $U_i \leq 30 \text{ V}$, $I_i \leq 140 \text{ mA}$, $P_i \leq 1 \text{ W}$
Intrinsically safe data (Ex ia IIC)	$C_i \leq 10 \text{ nF}$, $L_i \leq 10 \text{ mH}$, $U_i \leq 30 \text{ V}$, $I_i \leq 100 \text{ mA}$, $P_i \leq 0.75 \text{ W}$

TEMPERATURE DATA

	EXPLOSIVE GAS ATMOSPHERE TDR-2000-A-G-_ Ex ia IIB, Ex ia IIC			EXPLOSIVE DUST ATMOSPHERE TDR-2000 -A- D-_ Ex ia IIIC		
	+80°C	+90°C	+100°C	+80°C	+90°C	+100°C
Maximum permissible process temperature at the antenna	+80°C	+90°C	+100°C	+80°C	+90°C	+100°C
Maximum permissible surface temperature at the process connection	+75°C	+90°C	+100°C	+75°C	+90°C	+110°C
Temperature class	T6	T5	T4	T85°C	T100°C	T110°C

PROCESS TEMPERATURE DATA

TYPE	FLANGE TEMPERATURE
Transmitter	-30°C ... +90°C

Lower or higher temperature for non-Ex version on special request.

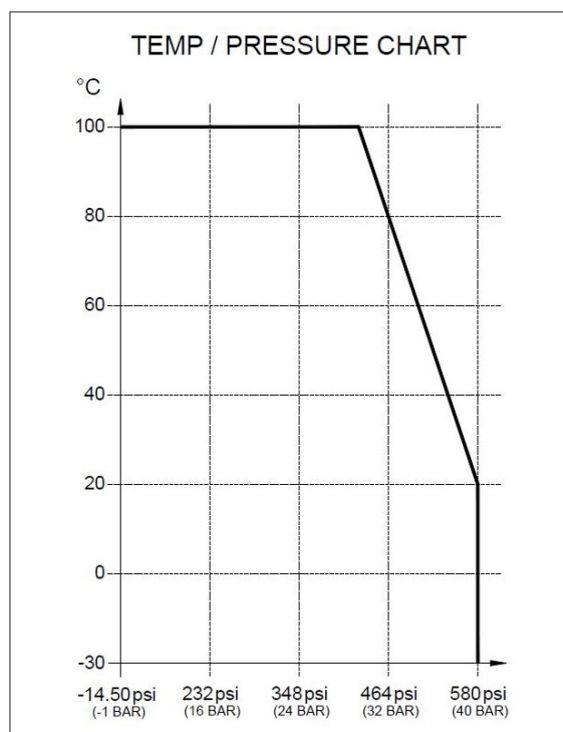

VI. MECHANICAL INSTALLATION



WARNING: REMOVE POWER FROM THE UNIT BEFORE INSTALLING, REMOVING, OR MAKING ADJUSTMENTS.



CAUTION: CARRY USING BOTH HANDS, LIFTING THE DEVICE CAREFULLY BY THE CONVERTER HOUSING. IF NECESSARY, USE LIFTING GEAR. NO ATTEMPT SHOULD BE MADE TO LIFT THE INSTRUMENT BY ITS PROBE. THE DEVICE WILL WEIGH BETWEEN 7 AND 25 LBS (3 - 12 KG).



CAUTION: THE PROBE IS A CRITICAL GAUGE COMPONENT. DO NOT DAMAGE. HANDLE WITH CARE.



CAUTION: FRAGILE ELECTRONICS. AVOID JOLTS, DROPPING, IMPACTS, ETC.



CAUTION: AVOID CABLE KINKS AND FRAYING. DO NOT COIL THE CABLE LESS THAN 16 IN (400 MM) IN DIAMETER. CABLE KINKS OR FRAYING WILL CAUSE MEASUREMENT ERRORS.



CAUTION: INSTALL A SUNSHADE IF THE UNIT IS EXPOSED TO DIRECT SUNLIGHT. LCD TECHNOLOGY IS USED FOR THE DISPLAY AND CAN BE DAMAGED IN DIRECT SUNLIGHT.

GENERAL INSTALLATION

1. Empty the vessel or at least reduce the material level below the length of the cable probe.
2. Determine location of where probe should be on the top of the tank. Consider the following:
 - a. Cable probe should be at least 12 in (30 cm) away from any metal surface.
 - b. Do not install unit close to material entry flow. Pouring the product directly onto the cable probe will give false readings and can cause excessive wear to the unit.
 - c. Install a deflector plate if it is impossible to distance gauge from the entry location.
 - d. For round, center fill, center discharging vessels, it is recommended that mounting should be located at a point approximately 1/3 of the vessel radius from the vessel wall.
 - e. For other types of vessel shapes, contact the manufacturer for assistance in determining ideal mounting location.
3. Add lubricant or sealant in the 1 1/2" NPT coupling to avoid seizing.
4. Insert TDR unit, with weighted end into the silo, and mount the unit to the top of the tank using a 1 1/2" NPT half coupling.
 - a. If direct mounting is not possible, a nozzle may need to be used.
 - b. When mounting a nozzle, the diameter of the nozzle must be great than the height. Take note of additional height due to nozzle; add as needed to the probe length.

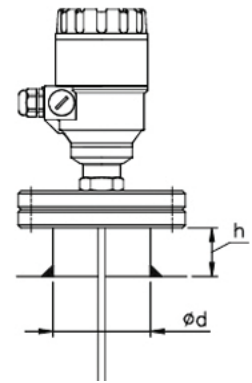

CAUTION: DO NOT USE NOZZLES THAT PENETRATE INTO THE TANK. THIS WILL DISTURB THE EMITTED PULSE.

5. Unit should hang straight down into the vessel. See Probe Alignment section for more details about non-standard situations.
6. Tighten the unit to the 1 1/2" NPT coupling using the hex nut at the base of the head.
7. Proceed to Electrical Section for wiring instructions.

INSTALLATION OF MULTIPLE DEVICES

If two devices are being used in the same tank, the units should be mounted at a distance of at least 6.5 ft (2 m) away from each other. If not, interferences from the electromagnetic (EM) fields generated by both instruments may

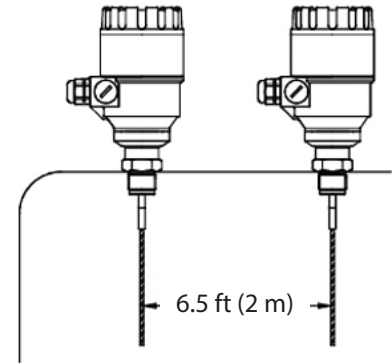

CABLE PROBE ALIGNMENT

The cable probe should be installed in a manner that allows the cable probe to hang straight. The probe should not make direct contact with the bottom or the side of the tank. The cable probe must be at least 12 in.

(30 cm) away from side walls, wall reinforcements, mixers, etc to avoid kinks or entanglements that will influence the cable probe's electromagnetic field and the material readings.

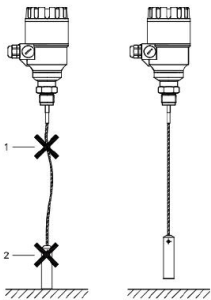

CABLE PROBE TETHERING

The cable probe should be installed so that the counterweight can be tethered to the cone of the tank; a pigtail can also be used. When tethering the cable probe it should be attached to the tank in such a manner as to allow the cable probe to move as the material level changes. Tethering of the cable probe is done to provide an electrical path for discharge of static build-up. The cable probe should not be anchored in a fashion that adds any additional load to the top of the tank.



WARNING: TETHERING OF THE CABLE PROBE IS REQUIRED TO PREVENT STATIC DISCHARGE AND ELECTRICAL SHOCK.

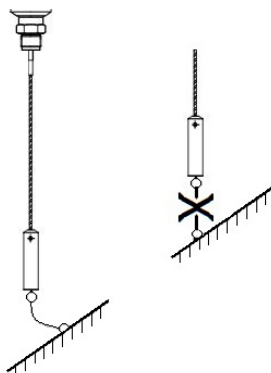

SHORTENING THE CABLE PROBE

The cable probe may be shortened to accommodate a process or tank change. The TDR-2000 programming can be adjusted to work with a new probe length. Ensure that the new cable length can be installed following the installation requirements described previously. Please contact the manufacturer for assistance with shortening the cable probe and additional set-up procedures and requirements.

VII. ELECTRICAL INSTALLATION



WARNING: REMOVE POWER FROM THE UNIT BEFORE INSTALLING, REMOVING, OR MAKING ADJUSTMENTS.

GENERAL SAFETY

When using electrical equipment, you should always follow basic safety precautions, including the following:

- The installation and wiring of this product must comply with all national, federal, state, municipal, and local codes that apply.
- Properly ground the enclosure to an adequate earth ground.
- Do not modify any factory wiring. Connections should only be made to the terminals described in this section.
- All connections to the unit must use conductors with an insulation rating of 300 V minimum, rated for 105 C, a minimum flammability rating of VW-1, and be of appropriate gauge for the voltage and current required (see specifications).
- Do not allow moisture to enter the electronics enclosure. Conduit should slope downward from the unit housing. Install drip loops and seal conduit with silicone rubber product.

DISCONNECT REQUIREMENTS FOR PERMANENTLY INSTALLED EQUIPMENT

A dedicated disconnecting device (circuit breaker) must be provided for the proper installation of the unit. If independent circuits are used for power input and main relay outputs, if applicable, individual disconnects are required. Disconnects must meet the following requirements:

- Located in close proximity to the device
- Easily accessible to the operator
- Appropriately marked as the disconnect for the device and associated circuit
- Sized appropriately to the requirements of the protected circuit (See specifications)

CONDUIT CABLE CONNECTION

- Two (2) M20 x 1.5 and two (2) 1/2" NPT female conduit openings are provided in the housing for input and output wiring. When only one conduit opening is used for installation, the unused opens must be sealed with a suitable type of plug.

POWER SUPPLY REQUIREMENTS

- 18 to 35 VDC

WIRING TDR TO POWER SUPPLY

1. Turn off all power to unit.
2. Detach the cover of the unit.
3. Guide the cable into the housing through the cable gland
4. Remove a 0.16 in (4 mm) length of insulation from the wires and cut away the free part of the shielding.
5. Connect the wires of the current loop to terminals 2 and 3 (any polarity). See Figure 1.
6. Pull back the cable until 0.39 in (10 mm) of length remains in the housing behind the cable gland.
7. Tighten the cable gland using a wrench.
8. Check the connection of wires and the tightness of the cable gland.
9. Properly ground the unit. Screw type terminal on the housing, maximum cable cross-section: 0.006 in² (4 mm²). Grounding resistance $R < 1$ ohm. The shielding of the signal cable should be grounded at the control room. Avoid coupling of electromagnetic noises and place the signal cable away from power-current cables.



WARNING: UNIT HOUSING MUST BE GROUNDED FOR PROPER FUNCTION.

10. Return power to the unit.
11. If unit has been programmed by the company, it is now ready to begin taking readings. If unit needs to be reprogrammed for the vessel, proceed to the Set Up Section.

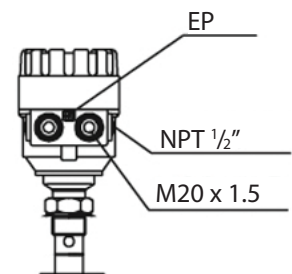

Figure 1: Basic 24 V Wiring – TDR to Power Supply

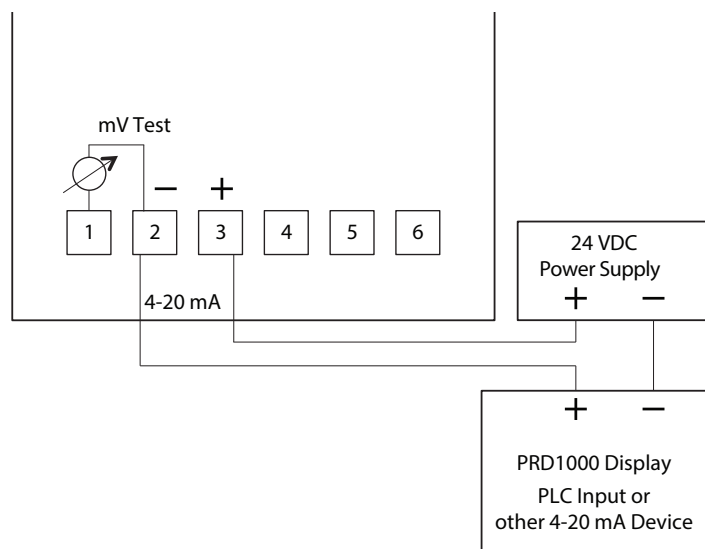
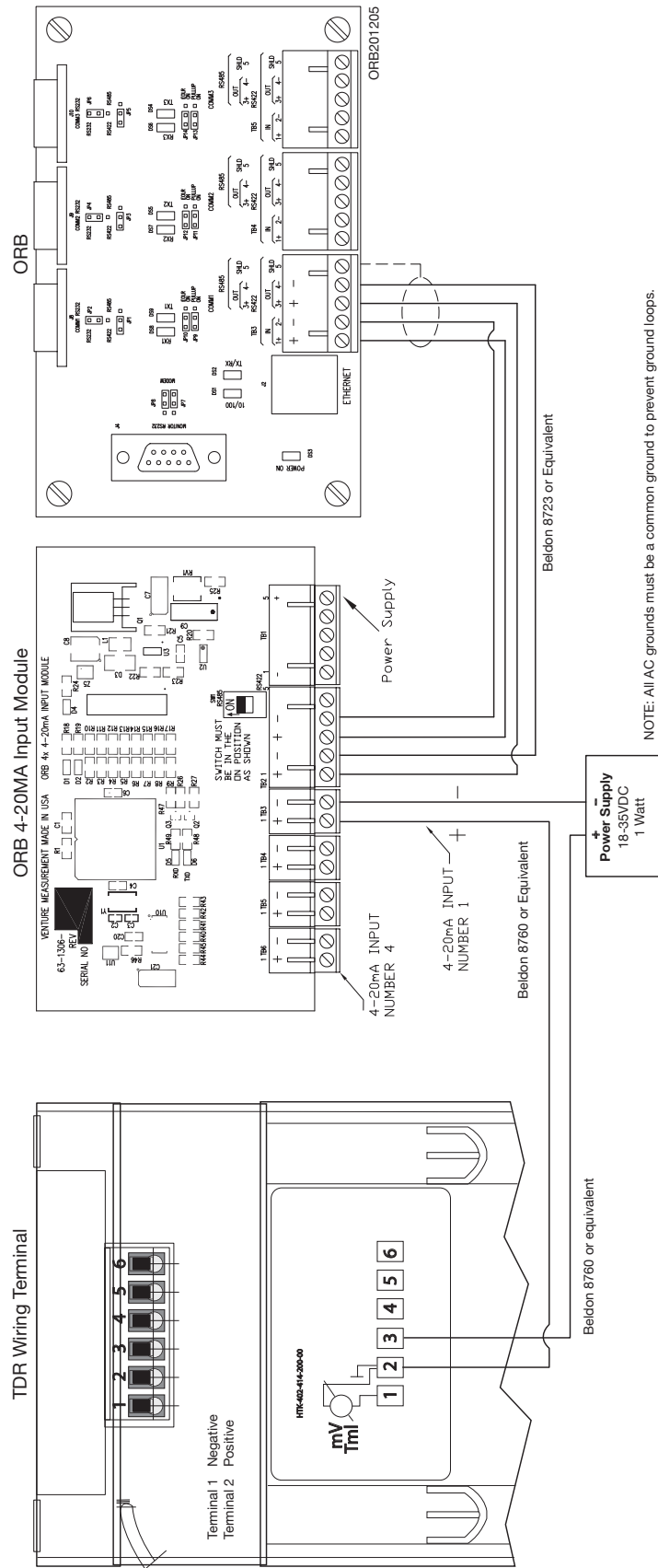
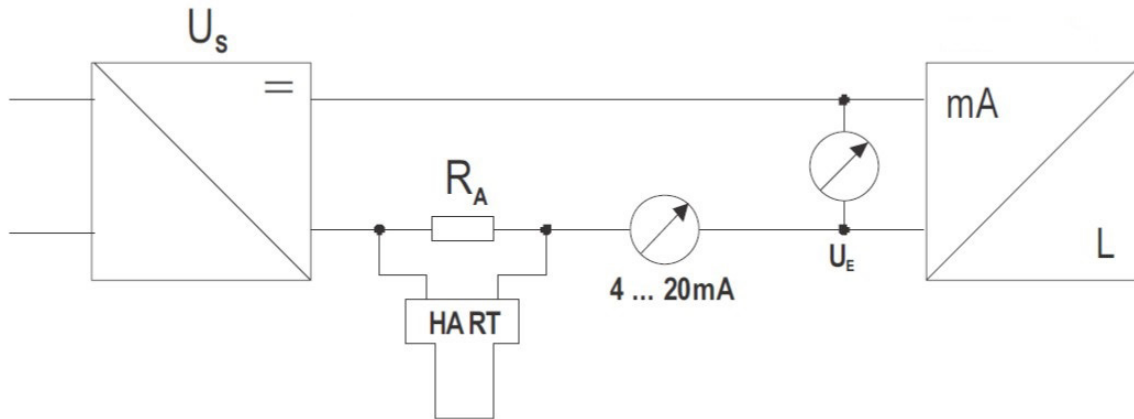

Figure 2: TDR to ORB Wiring Diagram



Non-Hazardous Duty Version



Hazardous Duty Version

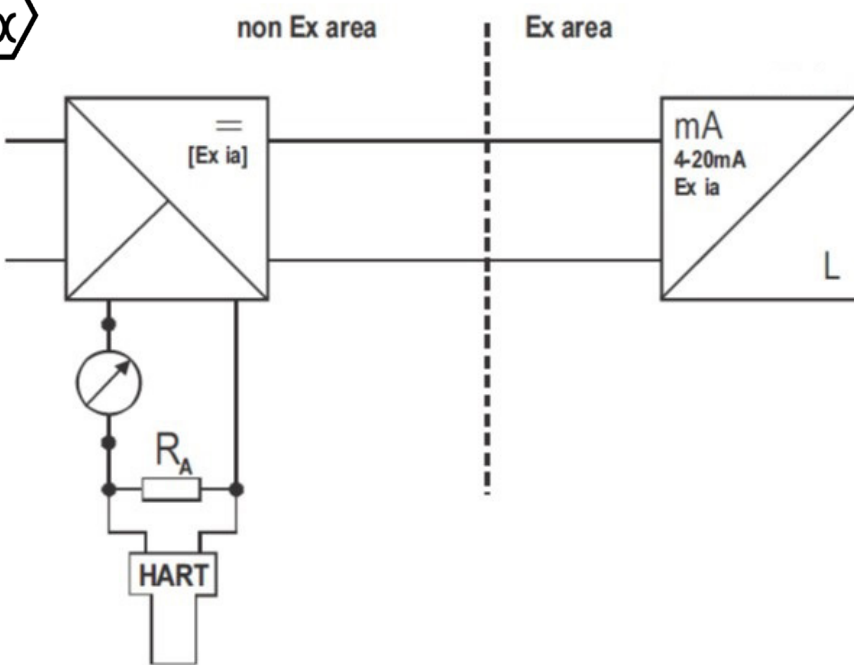

VIII. SET- UP

PROGRAMMING

Units shipping directly from the factory have been programmed according to the customer requirements on the Application Data Sheet (ADS). If no changes to the tank have occurred, unit will be ready for use after installation and no additional programming is required.

Changes to the unit, such as shortening of the cable probe length or adjusting the 4-20mA range may require changes to set-up

VALUES FOR SETTING UP THE UNIT

Figure 3. Measurement Set-up Guide

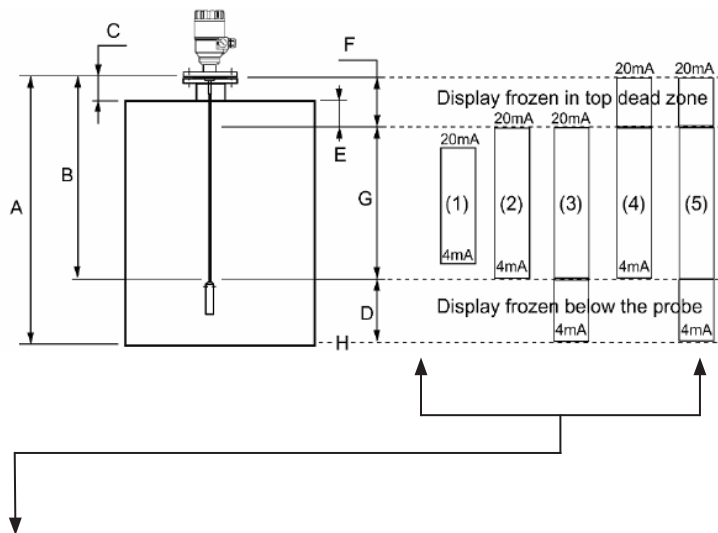

- A = Tank Height
- B = Probe Length
- C = Detection Delay
- D = Non-Measurable Zone
- E = Minimum distance between non-measurable zone and dead zone
- F = Upper Dead Zone
- G = Measuring Range
- H = Reference Point at Tank Bottom

1	The "current output" range is smaller than the maximum possible measuring range	
2	The "current output" range is equal to the measuring range	Scale Min: 4 mA = Tank Height (A) - Probe Length (B) + Reference Point (H)
		Scale Max: 20 mA = Tank Height (A) - Dead Zone (F)
3	The "current output" range is greater than the measuring range	Scale Min: 4 mA = 0.0
		Scale Max: 20 mA = Tank Height (A) - Dead Zone (F)
4	The "current output" range is greater than the measuring range	Scale Min: 4 mA = Tank Height (A) - Probe Length (B) + Reference Point (H)
		Scale Max: 20 mA = Tank Height (A)
5	The "current output" range is greater than the measuring range	Scale Min: 4 mA = 0.0
		Scale Max: 20 mA = Tank Height (A)

PROGRAMMING WITH THE DISPLAY



CAUTION: THE DISPLAY OF THE INTEGRAL UNIT IS BASED ON LCD TECHNOLOGY. DO NOT EXPOSE THE INTEGRAL DISPLAY UNIT TO CONTINUOUS DIRECT SUNLIGHT AND AVOID DAMAGE TO THE DISPLAY.

1. Determine full and empty points relative to the probe. (Top and bottom blind)
2. Remove cover.
3. Power unit with 24 VDC. A milliamp meter is recommended for confirmation of settings.

NOTE: It may take up to two (2) minutes for the unit to initialize.

4. To access the Main Menu, press and hold the E (Enter) button for approximately 3 seconds.

NOTE: Response time of the unit will be delayed; hold button for two (2) seconds and release, wait for display to respond.

NOTE: The reference point for the distance measurements is the bottom of the 1-1/2" NPT fitting.

5. Press ↓ to get to the Menu Options.
 - a. Press ↓ for Basic Set Up, then press E
 - b. Choose required option, press E
 - c. Make changes to values as required.
 - i. To move spots in the value, use the → to highlight the value to change.
 - ii. To increase the value, press the ↑ to decrease the value press the ↓.

NOTE: The values are not looped.

- d. Press E to accept changes.

BASIC MENU OPTIONS

NAME	DESCRIPTION
Tank Height	The tank height forms the basis for calculating the level measurements and for the current output. The value is always equal to the actual probe length plus 4 in (100 mm).
Dead Zone	Dead zone is the minimum measuring distance from the bottom of the process connector to the surface of the material. This value does not generally change; minimum value is 15.75 in (40 cm).
Close End Blocking	Prohibits signal detection, allowing for the masking of distributing top reflections near the process connection. Value can be equal or smaller to the Dead Zone value. It is recommended to keep a difference of 4 in (100 mm) between the two values.
Dampening Time	Filter (dampen) ripples of the measurement and current output. Range is 0 to 100 seconds
Probe Length	This will be the same value as tank height

OUTPUT SET UP

NAME	DESCRIPTION
Current Mode	<ul style="list-style-type: none"> • Level = 4 mA will be at the bottom of the probe • Distance = 4 mA will be at the top of the probe • Volume (Used with a strapping table only) = 4 mA will be at the bottom of the probe • Ullage Volume (Used with strapping table only) = 4 mA will be at the top of the probe
Current Minimum	Bottom deadband distance; minimum is 18 in. (46 cm)
Current Maximum	Effective span = Probe Length + 4 in (100 mm) – Top Deadband

FAILURE CURRENT

NAME	DESCRIPTION
Hold	Unit will hold the last good reading taken
22 mA	Unit will read 22 mA

ERROR DELAY

Choose from NONE, 10 seconds, 20 seconds, 30 seconds, 1 minute or 2 minutes

APPLICATION

NAME	DESCRIPTION
1 Product, 1 Level	Standard choice
2 Products, 1 Level	For liquid models and applications

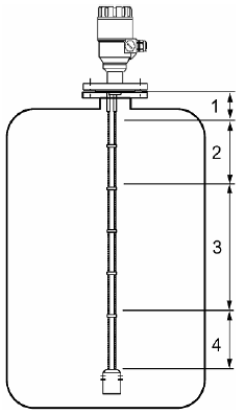

Zone 1: Dead and Detection Delay Zones

Marker "Tank Full" and "Level Lost" are displayed when the product enters the dead zone and no reflection is found. This will also occur once the level reflection is within the detection delay zone. The gauge assumes the tank is full and displays the maximum level value; the gauge searches for a reflection along the entire length of the probe.

Zone 2: Full Zone (and Dead Zone)

Marker "Tank Full" is displayed in this zone. If the gauge loses the signal in this zone, it reacts as in Zone 1; the tank is assumed to be full. The gauge searches for a reflection along the length of the probe.

Zone 3: Central Measurement Zone

The gauge searches along the length of the probe for the largest pulse reflection. If the pulse is lost, the reading freezes at the last value; marker "Level Lost" will be displayed.

Zone 4: Empty Zone

If the reflection is lost here then the gauge assumes the tank is empty and marker "Tank Empty" is displayed. The gauge searches for a reflection in this zone but makes a search along the entire length of the probe once every minute; the reading will remain frozen during this time. The short circuit reflection will become larger than the product reflection at this time.

IX. MAINTENANCE

The TDR-2000 does not require maintenance on a regular basis. In some very rare instances, however, the probe may need a cleaning from deposited material. This must be carried out gently, without damaging the probe. Repairs during or after the warranty period are carried out exclusively at the manufacturing facility. The equipment sent back for repairs should be cleaned or neutralized (disinfected) by the user.

X. TROUBLESHOOTING

Problem	Fault	Solution
GENERAL OPERATION		
"Flange not found" status marker on	The signal converter has been incorrectly configured to measure with a cable probe when it is equipped with a coaxial probe. This may be also due to installation on a long nozzle which has the effect of attenuating the flange pulse.	Contact Bindicator for the corrective procedure
"Delay out of limits" status marker on, reading is frozen	The emitted pulse has not been detected. The gauge will not work until it has been found.	The signal converter may need replacing. Please contact Bindicator.
"Negative voltage error"	Occurs when there is a problem with the time base on the HF board.	Contact Bindicator for the corrective procedure
"VC01 voltage error"		
"VC02 voltage error"		
"Reprogramming FPGA"		
Instrument is not accurate with a product that has a high dielectric constant. A constant offset is observed when taking measurements.	Tank height is not correct	Check current output and tank height parameters. If the signal converter has been replaced, verify that factory calibration parameters are still the same. Ask for the Bindicator factory calibration sheet (if not supplied) and the password for access to the factory menu.
The TDR-2000 2-wire indicates an incorrect level value	The TDR-2000 measures a non-valid reflection	Check the tank for obstructions and verify that the probe is clean. In the case the indicated level is close to the nozzle, increase the detection delay and the dead zone with the same ratio or increase the threshold level if the full measurement range is essential. The threshold level must be adjusted so that it masks the disturbances; it also gives enough margin for detection of the level pulse. Very large pulses along the measurement signal (same amplitude as the initial pulse) can be caused by a probe which is touching the nozzle or the tank side. Ensure that no contact is possible.
Instrument is not accurate when there are two or more phases in the tank.	The instrument may be incorrectly configured for this type of application; it is measuring the interface instead of the level	Contact Bindicator for the corrective procedure. May also check that there is a layer of more than 4 in (100 mm) of top product above the bottom product.
Problem	Fault	Solution

ERROR MESSAGES		
"Tank full" status marker on, reading frozen at max or min value	No fault. The level has reached (and possibly risen above) the top configured measurement limit and is either displaying the maximum (when measuring level) or minimum (when measuring distance) output.	None. Measurements should be normal once the level is in the configured measurement range.
"Tank empty" status marker on, reading frozen at max or min value	No fault. The level has entered the gauge's bottom dead zone and can no longer detect a return signal. Either the maximum (when measuring distance) or minimum (when measuring level) output is displayed.	None. Measurements should be normal once the level is in the configured measurement range.
"Tank full" and "Level lost" status marker on, reading frozen at max or min value	No fault. The level has entered the gauge's top dead zone and can no longer detect a return signal.	Empty the tank below the top measurement range limit and check the measurement.
"Level lost" status marker on, reading is frozen	The instrument has lost the level signal, has searched but not yet found the return pulse. This may occur if the pulse has dropped below the threshold. Parasite signals from the flange or obstructions in the tank may render the gauge unable to identify the correct signal.	Ensure that tank is emptied below maximum level and check the measurement. If the signal is not detected then modify the control threshold manually.
"Reference not found" status marker on	Occurs when there is a problem with the time base on the HF board.	Contact Bindicator for corrective procedure.
"Level lost" and "Reference not found" status markers on, reading frozen	The probe has received an electrostatic discharge.	The gauge will search for the level again and resume readings. If reading remains frozen then signal converter may have been damaged by ESD and may need replacing. Please contact Bindicator.
ELECTRICAL CONNECTIONS AND COMMUNICATION OUTPUT		
Current Output value < 4 mA	No power supply.	Check the power supply.
	Connection of the device is incorrect.	Check the connection between the device and the power supply.
	The calibration of the current output is incorrect.	Execute the calibration if you have authorized access or contact Bindicator Customer Support.
Reads 22 mA	An error has occurred.	This happens in case the range 4-20 mA/error 22 mA is selected. Check the status of the device by selecting the marker window.
	The device is in its start-up phase.	Wait 50 seconds. If the current value drops to a value between 4 and 20 mA and goes immediately back to 22 mA, contact Bindicator
The value at the current output does not correspond to the value at the display	The current output settings are incorrect.	Check the current loop and the connections.
Data communication via the digital interface is not working. The TDR-2000 is in its start-up phase, wait 50 seconds and try again	The communication parameters of the computer are set incorrectly.	Check computer setting (address/ device number).
	Bad connection to the interface.	Check connection.
	Current output value is < 4 mA.	If problem persists then contact Bindicator.
	Current output value is = 22 mA.	

MENU

90 REMOTE PROGRAM

91 BASIC SET UP

LENGTH 120

M, CM, MM*, FT, IN

TANK HEIGHT

DEAD ZONE

CLOSE-END BLOCKING

DAMPING TIME

PROBE LENGTH

92 OUTPUT SET UP

CURRENT MODE (93)

LEVEL

DISTANCE

VOLUME*

ULAGE VOLUME

CURRENT MIN

CURRENT MAX

FAILURE CURRENT (94)

HOLD

22 mA

ERROR CURRENT

ERROR DELAY (95)

NONE

10 SEC

20 SEC*

30 SEC

1 MIN

2 MIN

5 MIN

15 MIN

97 APPLICATION

THRESHOLD (98)

AMP=>00345<mV

DIST=1.25M

PULSE AMPL=820mV

GAIN=3

98 SERVICE

SERVICE CODE

APPLICATION TYPE (94)

1 LIQ 1 LEVEL*

2 LIQ 1 LEVEL

EPSILON R

Asterick menu values are default.

Parameters in the Service Menu are read-only parameters. Changing of these parameters requires the service code of the instrument.



150 Venture Boulevard
Spartanburg, SC 29306
Tel: (800) 778-9242
Fax: (864) 574-8063
sales@bindicator.com
www.bindicator.com

venture
MEASUREMENT

2016 All rights reserved.
All data subject to change without notice.

TDR180003 Rev. G