



IOM

M30218 Rev. A

SmartPD Meter
Installation & Operation Manual



SmartPD Meter Installation & Operation Manual

CONTENTS

I. HANDLING & STORAGE	1
Inspection and Handling	
Disposal and Recycling	
Storage	
II. GENERAL SAFETY	2
Authorized Personnel	
Use	
Misuse	
III. PRODUCT DESCRIPTION	3
Function	
Applications	
Features	
Technical Specifications	
Approvals	
Temperature and Accuracy Charts	
Figure 1. SND Ambient vs Process Temperature Limit	
Figure 2. SOP Ambient vs Process Temperature	
Figure 3. Typical Accuracy Curve (Water Calibration)	
Pressure Drop Charts	
Figure 4. Model SND Line Size B - 0.75" Bore	
Figure 5. Model SND Line Size C - 1.00" Bore	
Figure 6. Model SND Line Size D - 1.25" Bore	
Figure 7. Model SND Line Size F - 1.50" Bore	
Figure 8. Model SND Line Size G - 2.00" Bore	
Figure 9. Model SOP Line Size C - 1.00" Bore	
Figure 10. Model SOP Line Size G - 2.00" Bore	
IV. MECHANICAL INSTALLATION	10
Mounting Considerations	
Nutating Disc and Oscillating Piston Installation	
Figure 11. Typical Component Configuration	
Remote Enclosure Installation	
Figure 12. Remote Enclosure	
V. ELECTRICAL INSTALLATION	12
Integral Transmitter	
Figure 13. Integral Transmitter Wiring	
Figure 14. Maximum Load Resistance	
Remote Transmitter	
Figure 15. SmartPD Remote Wiring Diagram	

HART Communication
Figure 16. HART Wiring

VI. SET-UP	15
Transmitter	
Display Description	
Resetting Total Mode	
Accessing Simulate Mode	
Accessing Program Mode	
Program Mode Information	
Flow Type	
Rate Unit	
Total Unit	
Range Set	
Custom Scale	
Set Cal	
Decimal	
Special	
Direction	
VII. MAINTENANCE	20
Preventative Maintenance	
VIII. TROUBLESHOOTING	21
IX. DIMENSIONAL DRAWINGS	23

SAFETY SYMBOLS



WARNING:

IDENTIFIES CONDITIONS OR PROCEDURES, WHICH IF NOT FOLLOWED, COULD RESULT IN SERIOUS INJURY. RISK OF ELECTRICAL SHOCK.



CAUTION:

IDENTIFIES CONDITIONS OR PROCEDURES, WHICH IF NOT FOLLOWED, COULD RESULT IN SERIOUS DAMAGE OR FAILURE OF THE EQUIPMENT.

SmartPD Meter

I. HANDLING AND STORAGE

SAVE THESE INSTRUCTIONS

INSPECTION AND HANDLING

Do not dispose of the carton or packing materials.

Each package should be inspected upon receipt for damage that may have occurred due to mishandling during shipping. If the unit is received damaged, notify the carrier or the factory for instructions. Failure to do so may void your warranty. If you have any problems or questions, consult Customer Support at 800-778-9251.

DISPOSAL AND RECYCLING

This product can be recycled by specialized companies and must not be disposed of in a municipal collection site. If you do not have the means to dispose of properly, please contact Customer Support for return and disposal instructions or options.

STORAGE

If the device is not scheduled for immediate installation following delivery, the following steps should be observed:

1. Following inspection, repackage the unit into its original packaging.
2. Select a clean dry site, free of vibration, shock and impact hazards.
3. If storage will be extended longer than 30 days, the unit must be stored at temperatures between 32° and 158° F (0° to 70° C) in non-condensing atmosphere with humidity less than 85%.



CAUTION: DO NOT STORE A NON-POWERED UNIT OUTDOORS FOR A PROLONGED PERIOD.

II. GENERAL SAFETY

AUTHORIZED PERSONNEL

All instructions described in the document must be performed by authorized and qualified service personnel only. Before installing the unit, please read these instructions and familiarize yourself with the requirements and functions of the device. The required personal protective equipment must always be worn when servicing this device.

USE

The device is solely intended for use as described in this manual. Reliable operation is ensured only if the instrument is used according to the specifications described in this document. For safety and warranty reasons, use of accessory equipment not recommended by the manufacturer and any modification of this device is explicitly forbidden. All servicing of this equipment must be performed by qualified service personnel only. This device should be mounted in locations where it will not be subject to tampering by unauthorized personnel.

MISUSE

Improper use or installation of this device may cause the following:

- Personal injury or harm
- Application specific hazards such as vessel overflow
- Damage to the device or system

If any questions or problems arise during installation of this equipment, please contact Customer Support at 800-778-9251.

III. PRODUCT DESCRIPTION

FUNCTION

The SmartPD is a volumetric meter that provides total volume and flow rate measurements by way of an electronic transmitter. This 2-wire device provides an analog response by way of a 4-20 mA signal, digital feedback via HART communication, and a visual indication of change on an LCD. There are two variations of this meter; the SmartPD nutating disc (SND), and the SmartPD oscillating piston (SOP).

The SmartPD meter is capable of measuring volume and flow rate for a wide range of materials in a number of different industries. It is a compact, space saving design that eliminates the need for upstream and downstream pipe requirements. It is offered in a wide range of materials, finishes and line sizes.

APPLICATIONS

- Chemical Processing
- Industrial manufacturing
- Paint
- Pulp and paper
- Food Processing
- Concrete Batching
- Cosmetic
- Pharmaceutical
- Agricultural
- Automotive

FEATURES

- 2 wire loop powered
- 4-20 mA proportional to flow
- HART Communication
- 2 line digital LCD display
- Remote distance up to 50' (15 m)
- Provides total and flow rates
- Wide process temperature rating

TECHNICAL SPECIFICATIONS

FUNCTIONAL	
Fluid Types	Liquids
Temperature	See Temperature Graphs
PERFORMANCE	
Accuracy	SND Models: $\pm 1.5\%$
	SOP Models: $\pm 0.5\%$
Totalizer Repeatability	< 0.25%
Flow Rate Repeatability	0.25%
Typical Update Rate of Display	1 Second
Typical Update Rate of 4-20 mA Output	100 mS, 8 mA/second max
PHYSICAL	
Flow Direction	Unidirectional
Housing/Flanges	1.0 to 2.5", NPT and Flanges
Pipe Requirements	Typical Straight
Process Connections	Model Dependent NPT or Flange
Electrical Connections	3/4" NPT
Supply Voltage	24 VDC $\pm 10\%$
Line Size	Nutating Disc (SND Models): 0.75, 1.0, 1.25, 1.5, 2.0"
	Oscillating Piston (SOP Models): 1.0 and 2.0"
Mounting Position	Horizontal
Typical Straight Pipe Requirements	None

APPROVALS

CE

TEMPERATURE AND ACCURACY CHARTS

Figure 1. SND Ambient vs Process Temperature Limit

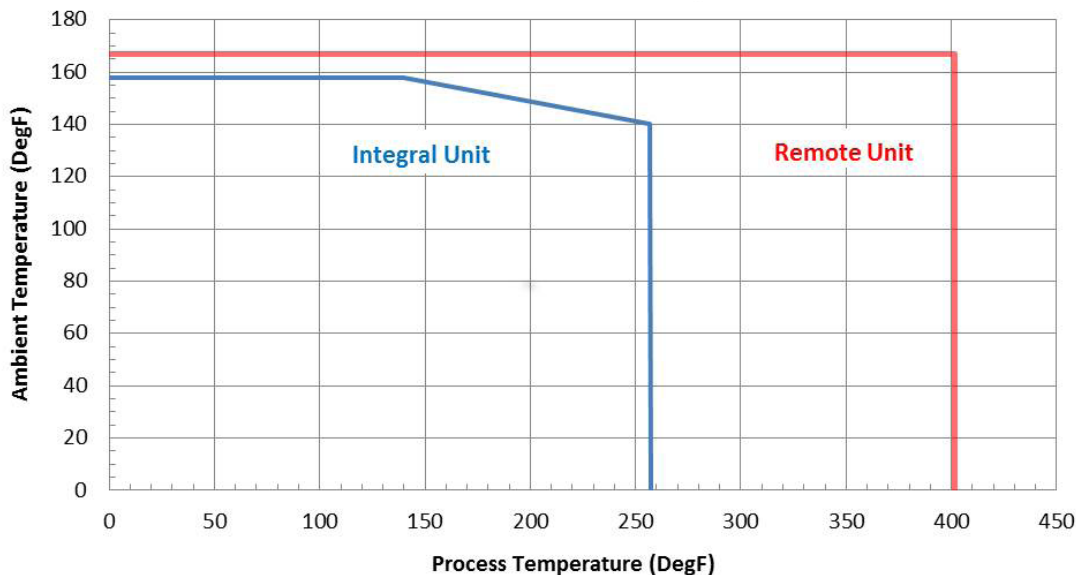

Figure 2. SOP Ambient vs Process Temperature

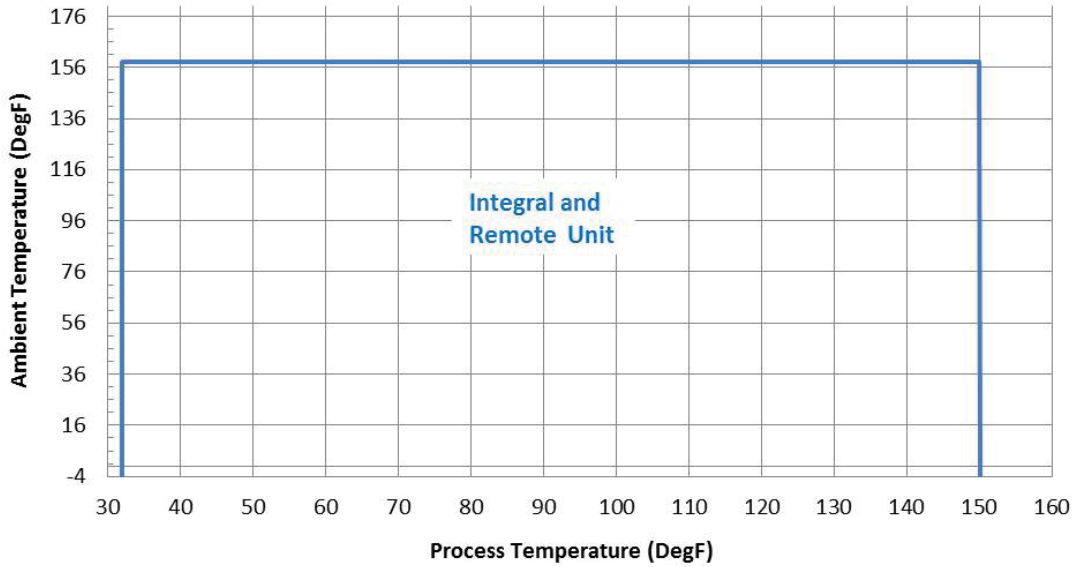
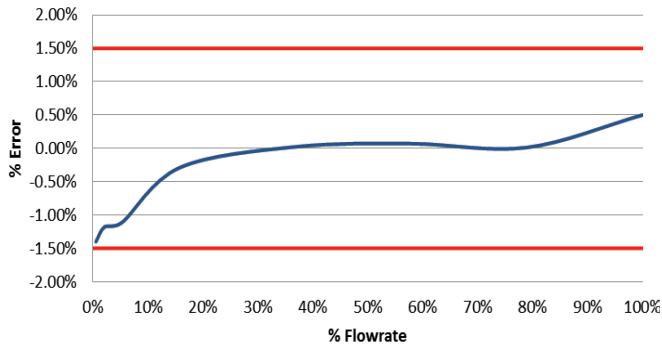
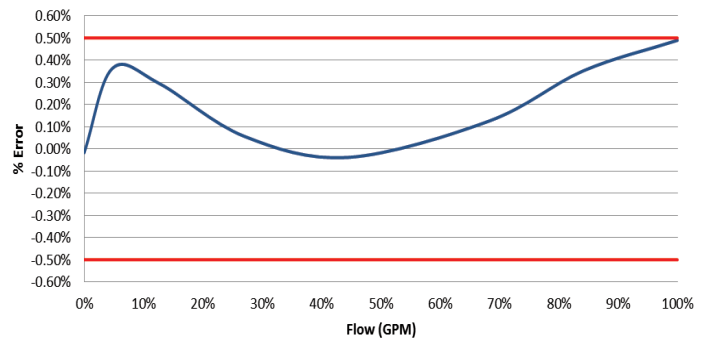

Figure 3. SND Typical Accuracy Curve (Water Calibration)



Notes: 1. Meter accuracy validated at 0%, 10% and 50% flowrates.
2. Repeatability of system is measured at 0.5%.

SOP Typical Accuracy Curve (Water Calibration)



Notes: 1. Meter accuracy validated at 0%, 50% and 100% flowrates.
2. Repeatability of system is measured at 0.25%.

FAMILY	OIL CALIBRATION (gpm)	WATER CALIBRATION (gpm)
SND Line Size B	1-20	2-20
SND Line Size C	2-30	3-30
SND Line Size D	3-50	5-50
SND Line Size F	5-100	8-100
SND Line Size G	8-120	8-100
SOP Line Size C	7-70	7-70
SOP Line Size G	15-150	15-150

Notes: 1. Actual flow ranges vary for different process materials.
Contact the manufacturer for instructions on selecting an appropriate meter for your application

PRESSURE DROP CHARTS

The plots below describe the maximum pressure drop for each meter and each flow group throughout the meter’s allowable flow range. To determine pressure drop:

1. Select the applicable meter size/chart.
2. Select the flow group curve (SND models only) that matches the application.

GROUP	MATERIAL VISCOSITY
1	Up to 30 SSU (.20 to 1.00 Centipoise)
2	31 to 450 SSU (1 to 90 Centipoise)
3	450 to 1,000 SSU (90 to 220 Centipoise)
4	1,000 to 5,000 SSU (220 to 1,100 Centipoise)
5	5,500 to 20,000 SSU (1,100 to 4,400 Centipoise)
6	20,000 to 50,000 SSU (4,400 to 11,000 Centipoise)

3. Find the location on the curve that corresponds to the maximum flowrate for the end application.
4. The maximum pressure drop is identifiable from the vertical axis on the chart.

Figure 4. Model SND Line Size B - 0.75” Bore

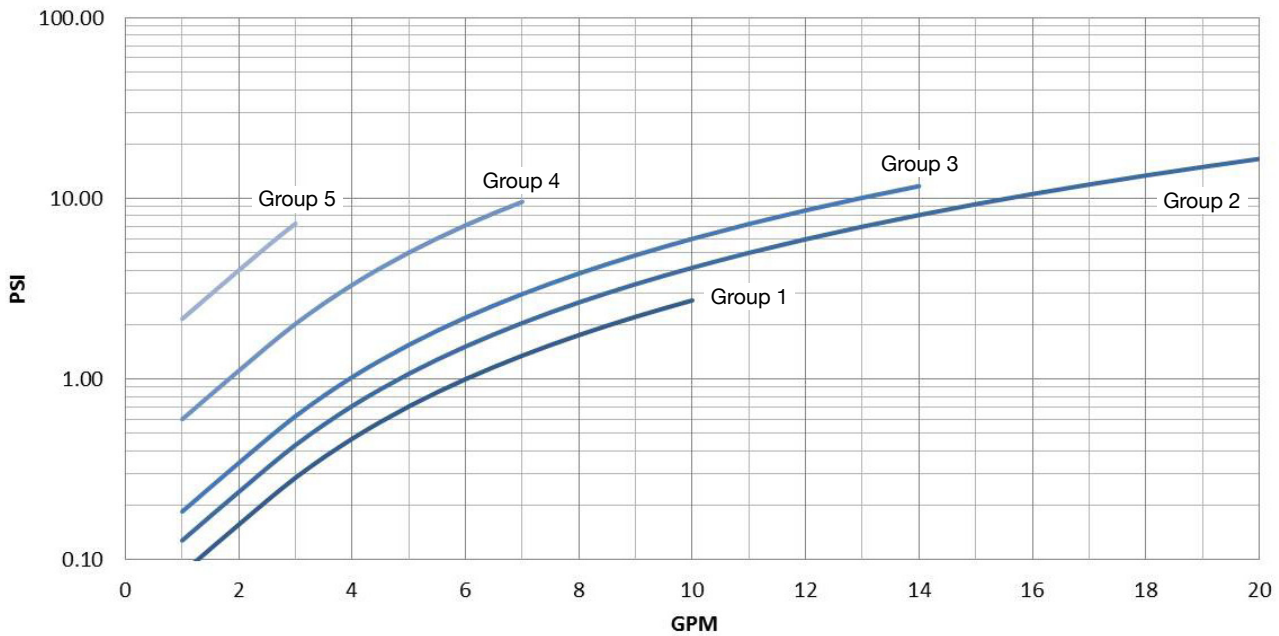

Figure 5. Model SND Line Size C - 1.00" Bore

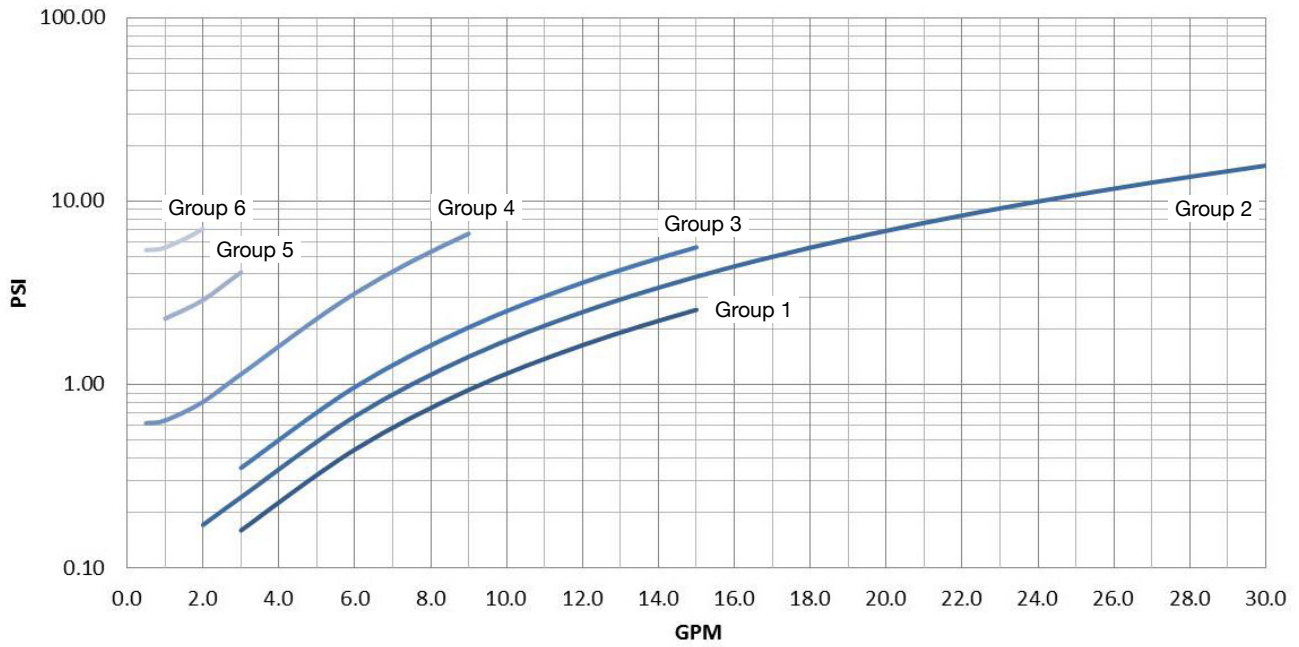

Figure 6. Model SND Line Size D - 1.25" Bore

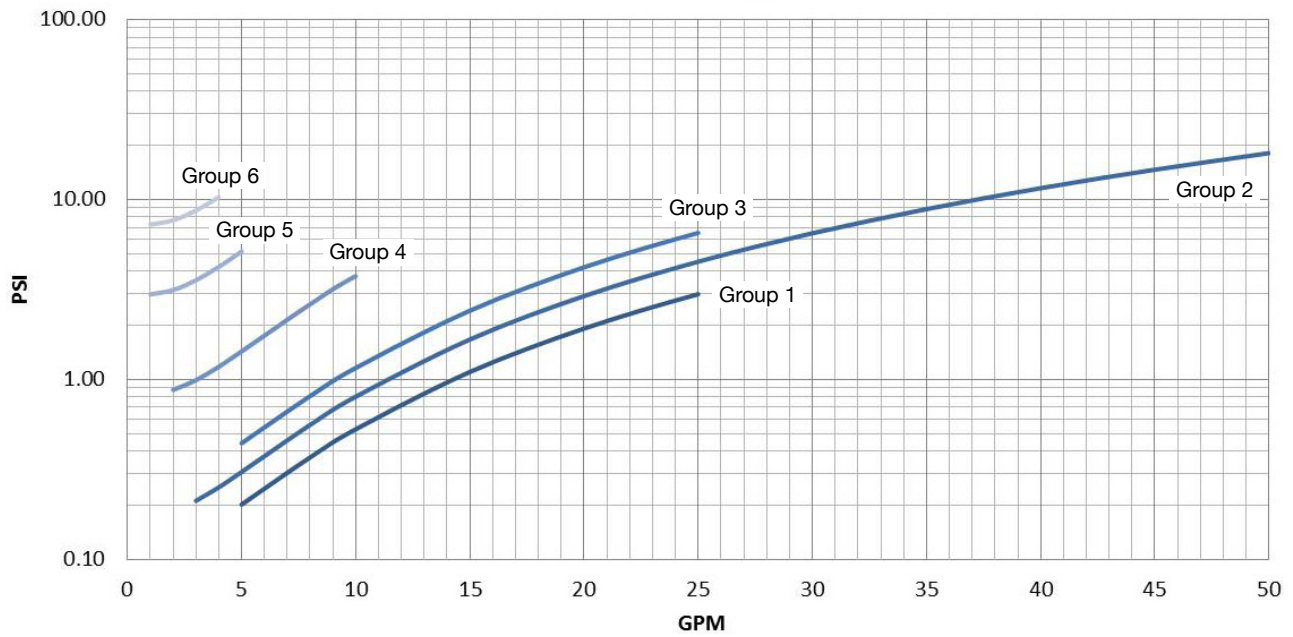

Figure 7. Model SND Line Size F - 1.50" Bore

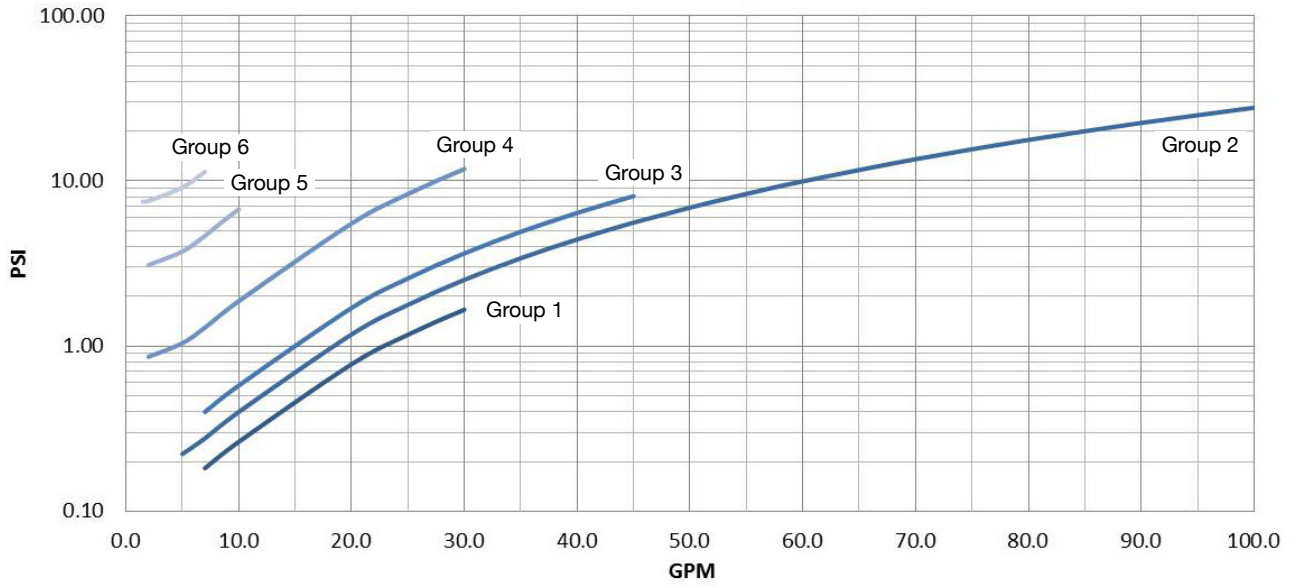

Figure 8. Model SND Line Size G - 2.00" Bore

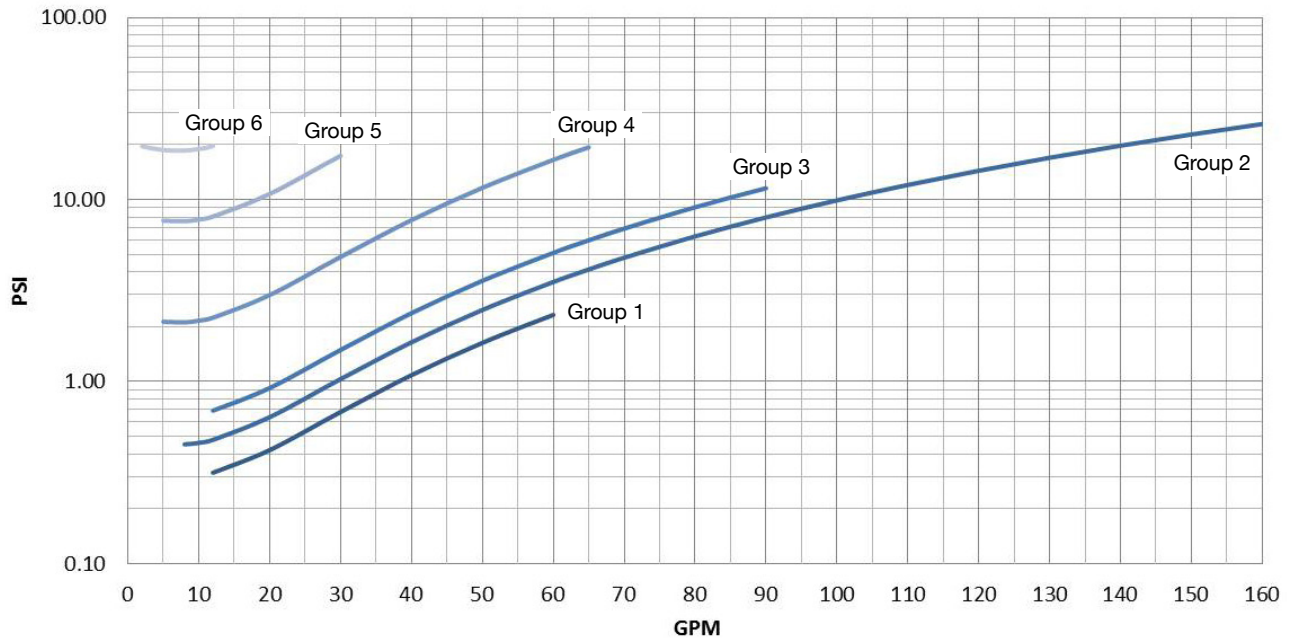

Figure 9. Model SOP Line Size C - 1.00" Bore

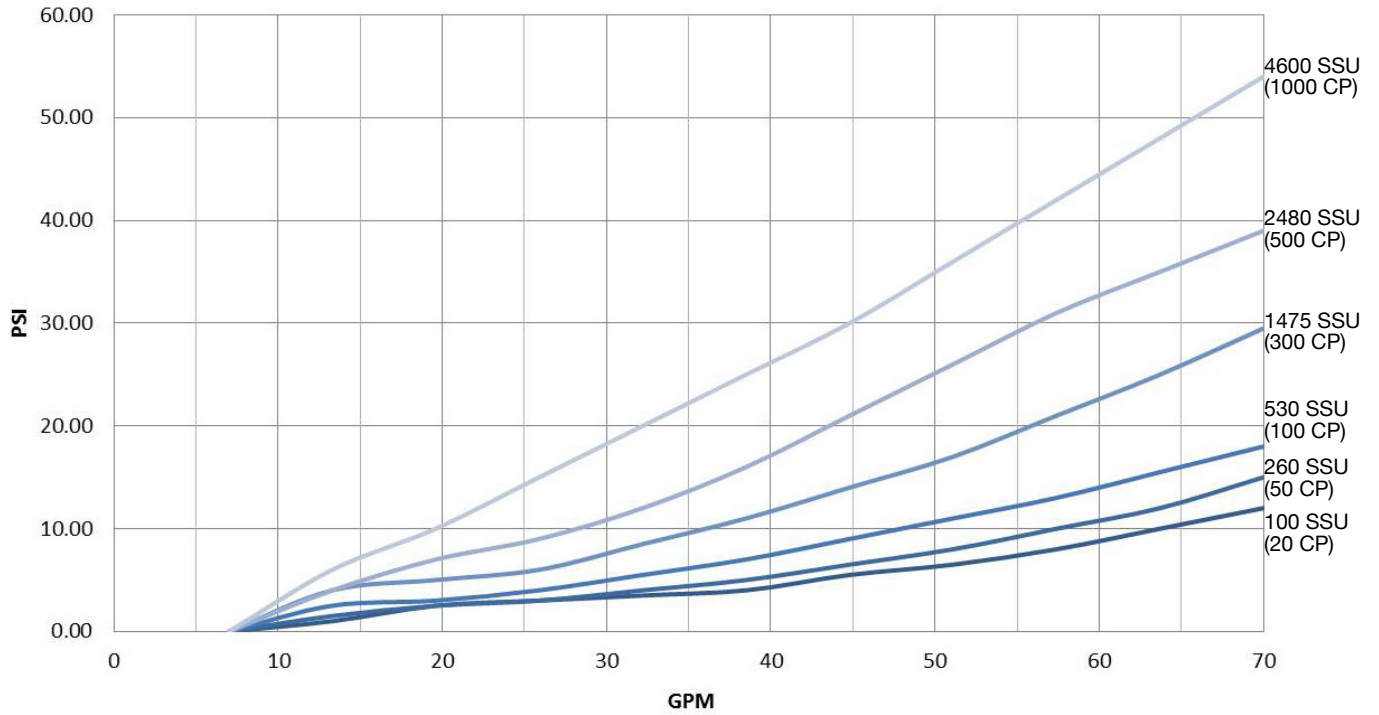
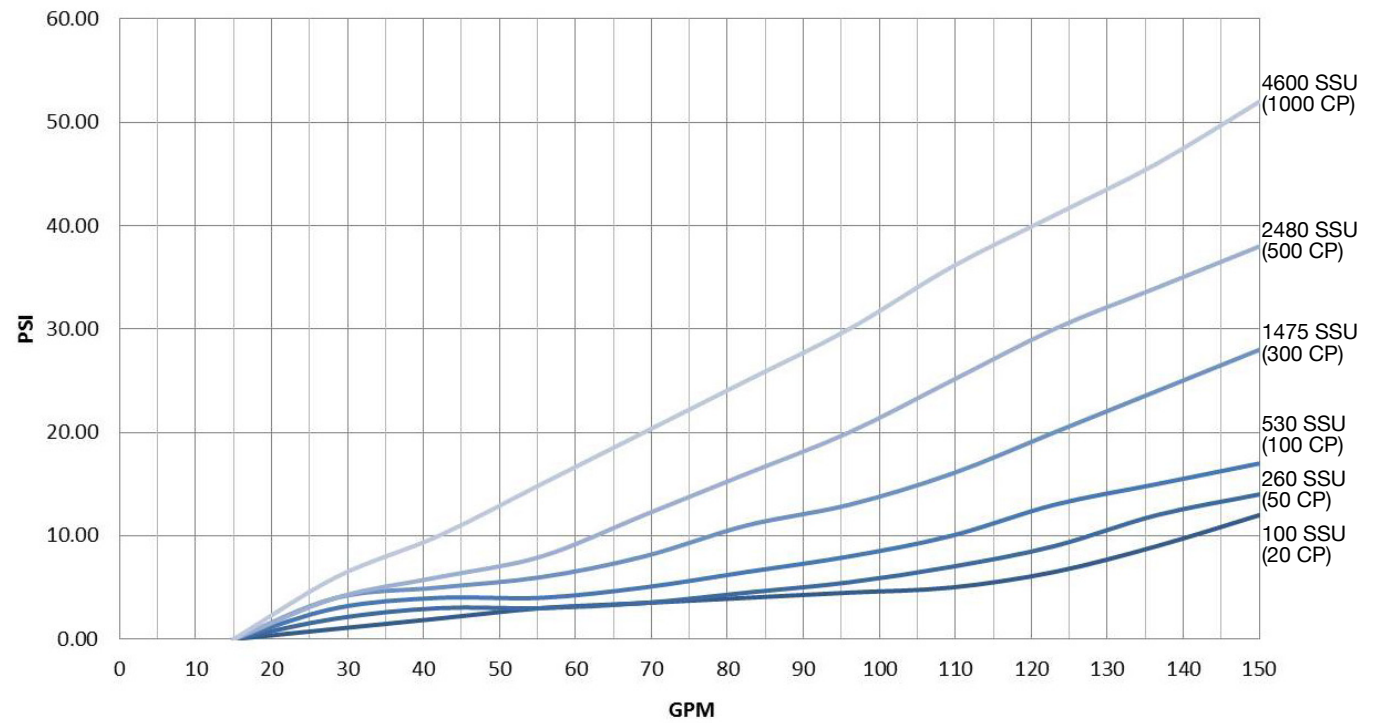

Figure 10. Model SOP Line Size D - 2.00" Bore



IV. MECHANICAL INSTALLATION



WARNING: USE THE METER ONLY WITH THE LIQUID FOR WHICH IT WAS ORDERED AND WITHIN THE SPECIFIED LIMITS OF PRESSURE, TEMPERATURE AND FLOW RATE.

MOUNTING CONSIDERATIONS

- If fluid is prone to sediment, consider adding a trap strainer to the system - arranging the strainer so it can be easily cleaned. See Figure 11 as an example.
- In gravity-pressure installations, set the meter to take advantage of all possible pressure head.
- In pump-pressure installations, set the meter on the discharge side of the pump.
- If the line must be kept in continuous service, install a bypass around the meter and strainer valves being installed or replaced.



CAUTION: THE METER IS NOT BI-DIRECTIONAL AND MUST BE POSITIONED IN THE PROPER ORIENTATION WITH RESPECT TO THE MATERIAL FLOW. THE DIRECTION OF FLOW TO/FROM EACH FITTING ON THE METER IS SHOWN ON THE METER HOUSING BY THE WORDS “IN” AND “OUT” OR BY AN ARROW. FLOW IN THE REVERSE DIRECTION WILL CAUSE THE TOTALIZER TO SUBTRACT FROM THE TOTAL.

NUTATING DISC OR OSCILLATING PISTON INSTALLATION

1. Drain system, if in use.
2. Determine where the meter will be installed within the current system.
3. Cut the pipe.
4. Connect meter couplings.
5. Flush line thoroughly with liquid to remove pipe cuttings, chips, etc.
6. The meter must be mounted with the transmitter housing extending vertically out of the meter. The transmitter can be rotated one full revolution on the pipe extension.

Figure 11. Typical Component Configuration

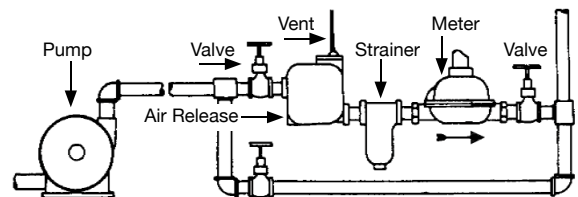

CAUTION: ROTATING THE TRANSMITTER BEYOND ONE REVOLUTION CAN DAMAGE THE INTERNAL WIRING OF THE UNIT.

7. Tighten meter into place.
8. Purge air from the line.
9. (Re)Fill system slowly to ensure no air is in the line. Meter is ready to take readings. Pipe must remain fully flooded at all times in order for the meter to take accurate readings; avoid passing air or vapor through the meter.

NOTE: To help keep air out, do not let the meter drain between periods of usage. Trap the meter in a depression in the pipeline if necessary. Keep suction lines and pump stuffing boxes tight. If air cannot be kept out of a line handling light oils or solvents, use an air release valve between the pump and meter.

NOTE: The meter must be operated within its proper capacity range; it can be operated at the full rated capacity without damage.

REMOTE ENCLOSURE INSTALLATION

1. Determine and clean location of remote enclosure; space should be at least 7.5 inches wide by 9 inches high (19.05 x 22.86 cm). See Dimensional Drawings section for detailed diagrams.
2. Screw tabs into the back of the enclosure, using screws provided – turning them to the desired angle.
3. Mark hole location on mounting location.
4. Depending on material of mounting location, pre-drill holes.
5. Hold enclosure and screw into mounting location, using screws provided by user.

Figure 12. Remote Enclosure

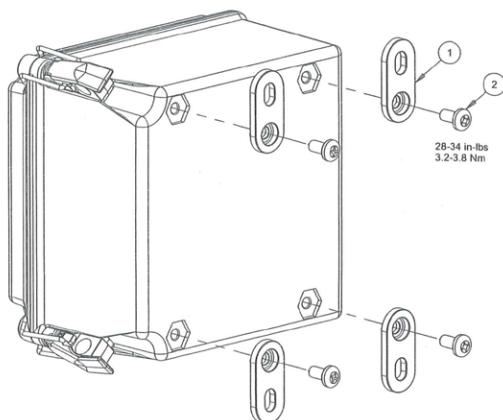

V. ELECTRICAL INSTALLATION

INTEGRAL TRANSMITTER

For meters with integral transmitter mounting, remove the rear enclosure cover to access the 4-20 mA loop connections. Connect the positive wire of the power source to the terminal block pin marked (+) and the negative (return) wire of the DC source to the terminal block pin marked (-). See Figure 13. Integral Transmitter Wiring.

Figure 13. Integral Transmitter Wiring

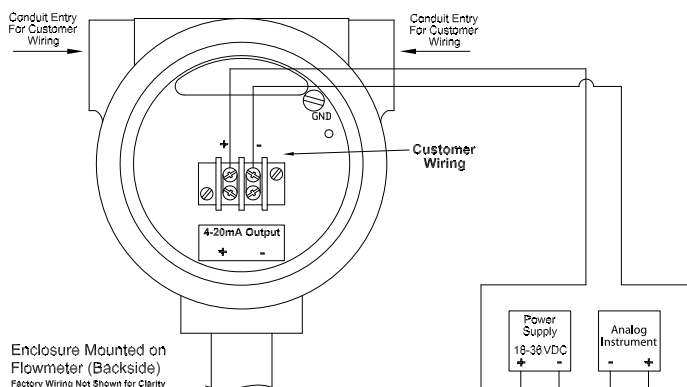

Analog instruments used to monitor the 4-20 mA loop, see Figure 13. Integral Transmitter Wiring, may have an internal sense resistor, or require a sense resistor to be placed in the loop with the instrument then connected across it. Since the SmartPD operates from a DC supply of $24 \pm 10\%$ volts, the total loop resistance allowed (sum value of all sense resistors) is limited.

Use the following formula to calculate the minimum power supply voltage required for the given total loop resistance. Make sure that the applied loop voltage range is within the recommended $24 \pm 10\%$ VDC:

- The Minimum Power Supply Voltage = $12 + (0.020 \times R_s)$, where R_s is the total loop resistance.
- Example: Assuming the internal sense resistor of the analog instrument is 500 Ohms, then Minimum Power Supply Voltage (MPSV) for proper operation of the transmitter is: $MPSV = 12 + (0.020 \times 500) = 22$ VDC

The graph below shows the relationship between power supply voltage and total loop resistance.

Figure 14. Maximum Load Resistance

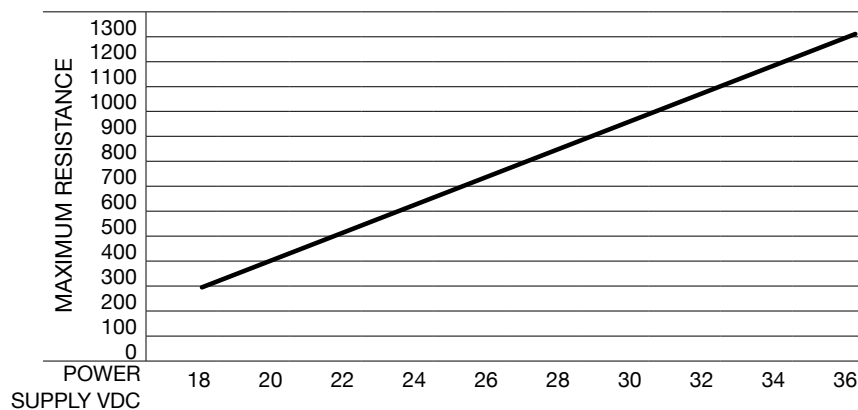

REMOTE TRANSMITTER

For remote mounted transmitters, remove the covers on the meter and the transmitter enclosure to access the terminal strips. Use a low capacitance, 4-conductor shielded cable (Belden 8102 or equivalent) to connect the junction box terminal strip to pins 1-4 of the remote electronics terminal strip. Connect the cable shield to pin 12 of the remote electronics terminal strip. Connect external loop power to pins 10 & 11 of the remote electronics terminal strip.

Figure 15. SmartPD Remote Wiring Diagram

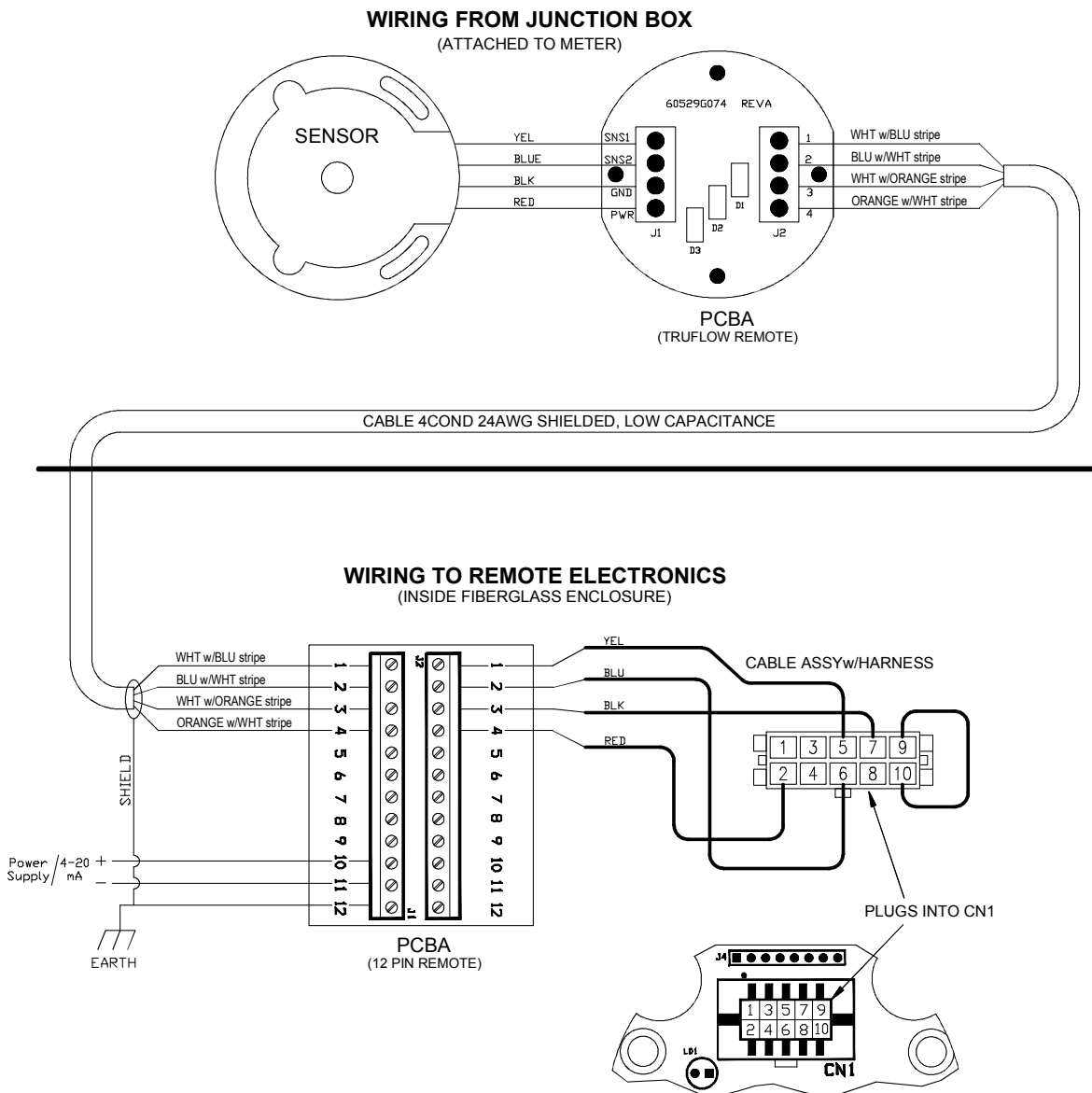

HART COMMUNICATION

The SmartPD can be accessed using a variety of HART compliant devices.

See Figure 16. HART Wiring. (HART Protocols are available; please see HART Protocol Guide.)

The received value for the HART current sense resistor is 500 Ohms as shown in Figure 16. To determine the minimum supply voltage, refer to the Minimum Power Supply equation. Remember that the value of the HART current sense resistor must be included in the total loop resistance.

Figure 16. HART Wiring

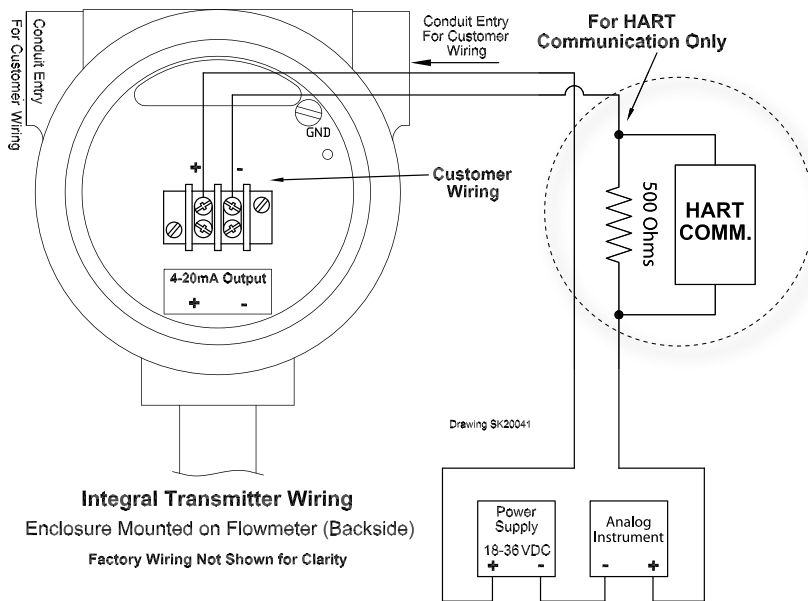

VI. SET-UP

Units are set up at the factory per customer requirements; no additional programming is required if adding unit into original application. Instructions are included below if changes have been made to the application and unit needs to be reprogrammed.



CAUTION: IT IS RECOMMENDED THAT THE TOTAL BE RESET BEFORE USE – SEE RESETTING TOTAL MODE FOR INSTRUCTIONS.

TRANSMITTER

DISPLAY DESCRIPTION

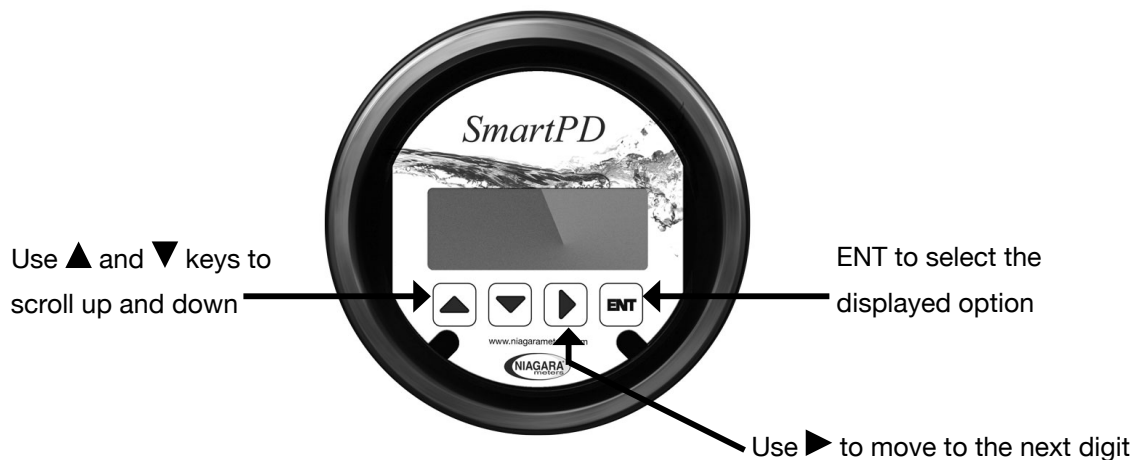

ACCESSING THE MENU

1. Press **ENT** and **▲** simultaneously
2. Enter password. Please Note: Default password is 8960
3. Use the **▲** and **▼** keys to increment or decrement the selected digit
4. Use the **►** key to select the next digit
5. Press **ENT** to accept the password

RESETTING TOTAL MODE

In order to reset the total for the flow meter, access the Main Menu by entering the password information. See ACCESSING THE MENU.

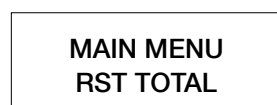

Once the RST TOTAL option is selected by pressing ENT the meter will ask you to verify by selecting YES or NO.

Use the scroll arrows to select YES or NO and then press ENT to accept the selection.

If NO is selected the meter will return to the main menu where another selection can be made.

If YES is selected the meter will perform the reset and display RST TOTAL COMPLETED on the display before returning to the main menu.

ACCESSING SIMULATE MODE

In order to enter simulation mode for the flow meter, begin by accessing the Main Menu using the password information. See ACCESSING THE MENU.

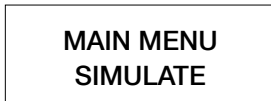

Press ENT to select simulate mode. The SIMULATE menu options are:

- 4 mA to force 4 mA output
- 8 mA to force 8 mA output
- 12 mA to force 12 mA output
- 16 mA to force 16 mA output
- 20 mA to force 20 mA output

Once the output is selected press ENT. An asterisk (*) will be placed by that output signal indicating this is the chosen signal. To end simulation, press the arrow keys until BACK is available and press ENT.

ACCESSING PROGRAM MODE

Please consult manufacturer before changing program settings.

In order to enter program mode for the flow meter, begin by accessing Main Menu by entering the password information. See ACCESSING THE MENU.

In Program Mode change Flow Type, Units, Range settings, Calibration, Display options, etc.

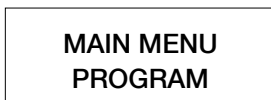

Once PROGRAM is displayed on the meter, press ENT to select.

The PROGRAM menu options are:

- | | |
|-------------------------------|----------------|
| • BACK (returns to main menu) | • CUSTOM SCALE |
| • FLOW TYPE | • SET CAL |
| • RATE UNIT | • DECIMAL |
| • TOTAL UNIT | • SPECIAL |
| • RANGE SET | • DIRECTION |

PROGRAM MODE INFORMATION

FLOW TYPE

To change Flow Type from volumetric or mass flow, scroll to MASS or VOLUME and press ENT. Once a selection is made an asterisk (*) will appear next to that selection made indicating which flow type has been selected. Once a selection has been made, scroll to the BACK option and press ENT to go back to the Main Menu.

RATE UNIT

The Rate Unit is the engineering units to be displayed for flow rate on the meter. Selection choices for rate unit vary based on flow type. Scroll to the desired units and press ENT. The meter will place an asterisk (*) next to the selected option. Scroll to BACK option once a selection has been made to return to the main menu.

Rate Options For Volumetric Flow

UNIT	DESCRIPTION	UNIT	DESCRIPTION
GPS	gallons/second	CFH	cubic feet/hour
GPM	gallons/minute	CFD	cubic feet/day
GPH	gallons/hour	BPM	barrels/minute
GPD	gallons/day	BPH	barrels/hour
LPS	liters/second	BPD	barrels/day
LPM	liters/minute	IGS	imperial gallons/second
LPH	liters/hour	IGM	imperial gallons/minute
MLD	mega liters/day	IGH	imperial gallons/hour
CMM	cubic meters/minute	IGD	imperial gallons/day
CMH	cubic meters/hour	NCH	normal cubic meter/hour
CMD	cubic meters/day	NLH	normal liter/hour
CFS	cubic feet/second	%	percentage
CFM	cubic feet/minute	SCM	standard cubic feet/minute

Rate Options For Mass Flow

UNIT	DESCRIPTION	UNIT	DESCRIPTION
GPS	grams/second	PPS	pounds/second
GPM	grams/minute	PPM	pounds/minute
GPH	grams/hour	PPH	pounds/hour
KPS	kilograms/second	PPD	pounds/day
KPM	kilograms/minute	STH	short tons/hour
KPH	kilograms/hour	STD	short tons/day
KPD	kilograms/day	LTH	long tons/hour
MTH	metric tons/hour	LTD	long tons/day
MTD	metric tons/day	%	percentage

TOTAL UNIT

The Total Unit is the engineering units to be displayed for the Totalizer on the meter. Selection choices for the Total Unit vary based on Flow Type. Scroll to the desired units and press ENT. The meter will place an asterisk (*) next to the selected option. Scroll to BACK option once a selection has been made to return to the PROGRAM menu.

Total Options For Volumetric Flow

UNIT	DESCRIPTION	UNIT	DESCRIPTION
GAL	gallon	CY	cubic yard
LIT	liter	CF	cubic feet
IGL	imperial gallon	CL	cubic liter
CM	cubic meter	BBL	bbl liquid
BL	barrel	HL	hectoliters
BSL	bushel		

Total Options For Mass Flow

UNIT	DESCRIPTION	UNIT	DESCRIPTION
G	grams	ST	short tons
KG	kilograms	LT	long tons
MT	metric tons	OZ	ounces
LB	pounds		

RANGE SET

The Range Set option scales the 4-20 mA output to the process variable. In order to set the Range Set, scroll to the Range Set option on the Program Menu and press ENT. Use the arrow keys to display the options. Selection choices for Range Set will vary based on the direction of the meter.

Unidirectional Meter Options:

- 4 mA
- 20 mA
- CUT OFF

Initial range values are 4 mA = 0 flow and 20 mA = Full Scale flow as designated by the invoice and application process. For a Unidirectional Meter the Cut Off will be the minimum flow that can be reported by the meter.

CUSTOM SCALE

The Custom Scale option is a percentage between 90 and 110, which can be selected to change the output factor to be displayed and transmitted. Select the desired option and press ENT to return to the PROGRAM menu.

SET CAL

The Set Cal option is set at the factory to match the transmitter to the target meter. This must not be changed without first consulting the factory.

DECIMAL

This option allows the decimal location that is displayed to be selected. The options are:

- 000000
- 0000.0
- 000.00
- 00.000

NOTE: The number of decimal digits will be limited by the full-scale value.

Scroll to the desired display option and press ENT. The meter will place an asterisk (*) next to the selected option. Scroll to BACK option once a selection has been made to return to the PROGRAM menu.

SPECIAL

- METER INFO will sequence through the serial number, firmware version, and model numbers, etc. that are assigned to the meter.
- CHANGE PW is the option to change the password for the meter
- DEFAULT resets the meter back to the original factory defaults set when the meter was shipped.
- FAULT HIST shows all the faults and warnings history that had occurred in meter during operation.
- CLR FAULT clears all active faults stored in the meter.
- TRIM provides an option to trim 4 mA and 20 mA output independent of flow.
- DAMPING provides an option to manage the displayed flow rate and mA output caused by severe turbulence or other conditions. Possible settings are 0 to 99 where 1 = 0.333 seconds, 2 = 0.666 seconds, 3 = 0.999 seconds, 90 = 29.97 seconds. The default setting is 3.
- DISPLAY provides the option to select the parameters to display on the meter. Standard is Flow Rate and Total. Options include Rate Only and Total Only.
- FAILSAFE provides the option to select the value the 4-20 mA is to transmit in the case there is a failure. Starting value is always ON LOW. Possible values are ON LOW, ON HIGH, and ON OTHER.
- Where ON LOW is 3.5 mA, ON HIGH is 22.5 mA, and ON OTHER is between 4 mA and 20 mA.

DIRECTION

The DIRECTION mode allows the transmitter to be set in clockwise or counter-clockwise direction. Scroll to CW for clockwise and CCW for counter-clockwise flow. Scroll to the desired display option and press ENT. The meter will place an asterisk (*) next to the selected option. Scroll to BACK option once a selection has been made to return to the PROGRAM menu.

VII. MAINTENANCE

No scheduled preventative maintenance is required for the units when properly applied and correctly installed. There is no cleaning required for the unit before or during installation.

VIII. TROUBLESHOOTING

DESCRIBE ISSUE	SYMPTOM	POSSIBLE CAUSE	SOLUTION
Display shows negative total or flowrate	Total and flowrate are shown with a negative '-' sign	Meter is installed backwards	Determine the direction of flow through the meter. Verify that material is flowing into the port of the meter marked with "IN" and out the port marked "OUT"
		Transmitter is configured for the wrong direction	If the meter is installed backwards, remove and rotate the meter 180 degrees. If the meter is installed correctly, change the DIRECTION setting from the PROGRAM menu to its alternate setting (CW for CCW, and CCW for CW) Reset the total from the MAIN MENU
Meter reads low at low flowrates	Meter reads low	An aging meters can result in poor accuracies at low flowrates.	Contact the factory for repair instructions or recalibration
Remote meter reads low at low flowrates	Meter reads low	Overtightening/loosening the remote head beyond 180 degrees can result in a meter reading low or damage to the electronics	Contact the factory for repair instructions or recalibration
Meter reads very high	Meter reads high	Incorrect calibration	Consult the factory to verify proper calibration numbers
Zero flowrate / intermittent flowrate displayed	Meter reads zero flow despite having process flow	Flowrates below those specified in the manual can result in inconsistent meter performance. This will appear as flowrates changing from random values to zero.	Verify there is adequate process flow Contact the factory for repair instructions or recalibration
		An aging meters can result in intermittent operation at low flowrates	
Display shows fault 5 immediately after power up	Display shows fault 5	Poor wiring connection from power supply	Check wiring connections for loose connections to the unit Cycle power
No Display	There are no characters displayed on the meter	Insufficient power supplied to the unit during power-up or normal operation	Check wiring connections for loose connections to the unit Check the supply voltage at the meter Press the ENT button to reinitialize the display Contact the factory for repair instructions or recalibration
Units displayed do not match the application	The customer's flowrate units do not match those displayed by the meter	Incorrect calibration	See the PROGRAM MODE INFORMATION section under SET-UP of this manual to change the RATE and TOTAL units

FAULT CODES	DESCRIPTION	ACTION TO TAKE
1	Internal 2.5 V reference voltage	Check whether stable DC power is connected to transmitter. Clear fault from Failsafe to RUN mode. If fault appears again after clearing then contact manufacturer.
2	Internal 1.25 V reference voltage	See Action for Fault Code 1
5	Bridge/HALL Sensor connector not plugged in	Connect sensor to transmitter
8	AD12 communication	See Action for Fault Code 1
14	Flash read error	
15	Flash write error	
17	Processor main clock failure	
18	Processor aux. clock failure	
20	Internal 2.5 V reference voltage warning	Please check whether stable DC power is connected to Transmitter
21	Internal 1.25 V reference voltage warning	Please check whether stable DC power is connected to Transmitter
23	Process variable over/under flow warning	Device detected flow range more/less than meter can handle. Refer to device specifications. Clear fault to switch from Failsafe to RUN mode

IX. DIMENSIONAL DRAWINGS

SND and SOP Models: INTEGRAL

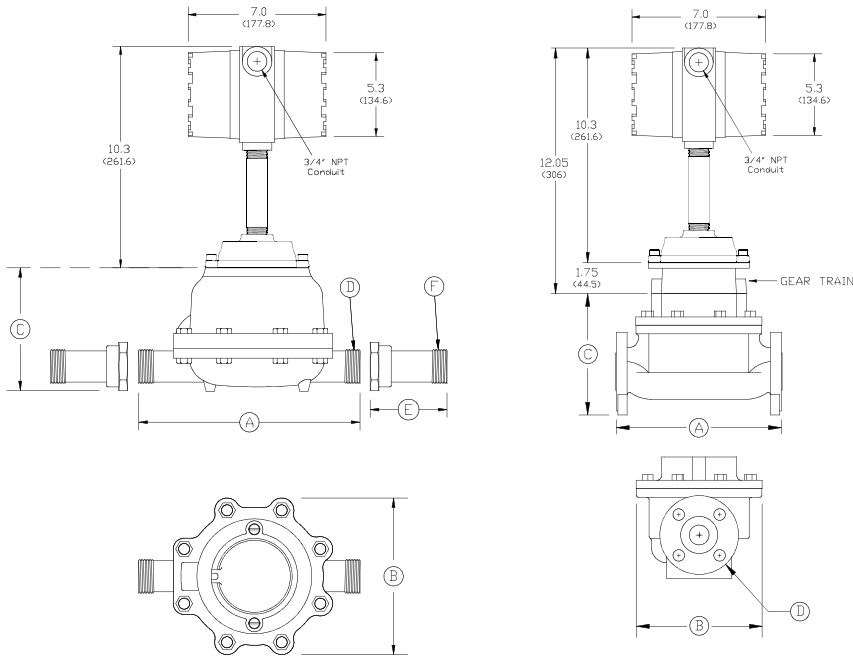

Meter Dimensions - inches (mm)

FAMILY	A	B	C	D	E
SND Line Size B	8.0	6.31	4.59	1.0" MNPT	2.5
SND Line Size C	9.0	7.25	4.88	1.25" MNPT	2.38
SND Line Size D	10.75	8.88	6.81	1.5" MNPT	2.75
SND Line Size F	12.63	8.78	6.93	2.0" MNPT	2.88
SND Line Size G	15.25	11.88	8.13	2.5" MNPT	3
SOP Line Size C	9.0	6.88	6.56	ANSI 1" 150 lb Class	x
SOP Line Size G	13.0	9.38	7.25	ANSI 2" 150 lb Class	x

SND and SOP Models: REMOTE - inches (mm)

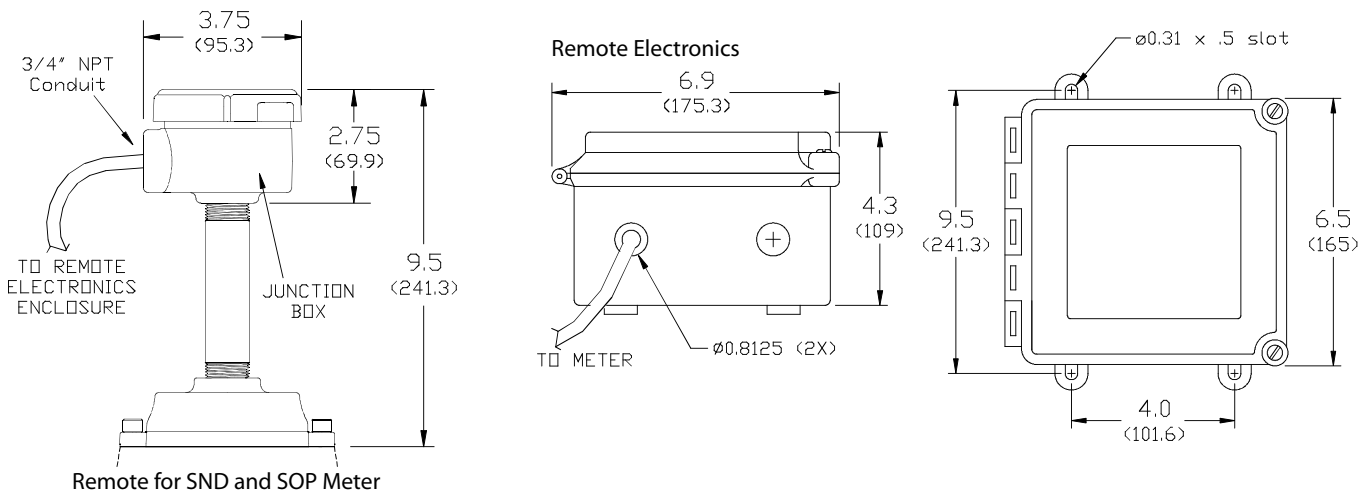



150 Venture Boulevard
Spartanburg, SC 29306
Tel: (800) 778-9251
Tel: (864) 574-3327
Fax: (864) 574-8063
sales@niagarameters.com
www.niagarameters.com

venture
MEASUREMENT

2013 All rights reserved.
All data subject to change without notice.

M30218 Rev. A