

**INSTRUCTIONS
for
STABILINE[®]
Automatic Voltage Regulators**

WHR34*S* Series**

**Three Phase
380Y/220 X 480Y/277 Volt
Single Control**

This manual also covers units with options that change the beginning of the model number to one of the following:
WHR64*S, WHR94*S, WHRS34*S, WHRS64*S, or WHRS94*S.

Superior Electric reserves the right to make engineering changes on all its products. Such refinements may affect information given in the instructions. Therefore, **USE ONLY THE INSTRUCTIONS THAT ARE PACKED WITH THE PRODUCT.**

WARNING: High voltages are present inside this unit during operation, Do not operate this unit unless all covers are in place. Installation and servicing should only be done by qualified personnel.



TABLE OF CONTENTS

SECTION	PAGE	SECTION	PAGE
1.0 INSPECTION	3	6.0 OPTIONS	7
1.1 UNPACKING.....	3	6.1 NON DESIGNATED OPTIONS	7
2.0 DESCRIPTION	3	6.2 MODEL No. SPECIFIED OPTIONS	7
2.1 GENERAL.....	3	6.3 ALL-BUCK AND ALL-BOOST OPERATION	9
2.2 STANDARD MODEL NUMBER SYSTEM	4	7.0 MAINTENANCE	10
2.3 THEORY OF OPERATION	5	8.0 TROUBLESHOOTING	10
3.0 INSTALLATION	5	9.0 RATING	12
3.1 TRANSPORTING THE REGULATOR..	5	9.1 POWER RATINGS.....	12
3.2 MECHANICAL INSTALLATION.....	5	9.2 VOLTAGE RANGE CHART.....	12
3.3 ELECTRICAL INSTALLATION.....	5	9.3 GENERAL SPECIFICATIONS.....	13
4.0 START UP	5	10.0 REPLACEMENT PARTS	14
5.0 OPERATION	6	10.1 ORDERING.....	14
5.1 CONTROL MODULE ASSEMBLY.....	6	10.2 CONTROL MODULE ASSEMBLY.....	14
5.2 SETTING OUTPUT VOLTAGE AND	6	10.3 POWER COMPONENTS	15
SENSITIVITY POTENTIOMETERS	6	10.4 REPLACEMENT BRUSH ASSEMBLY	15
5.3 REMOTE SENSING.....	6	10.5 AUX. POWER MODULE	15
		11.0 SCHEMATIC	16
		12.0 FLOOR MOUNT DIMENSIONS	17

1.0. INSPECTION

1.1. UNPACKING

When unpacking the unit, examine it carefully for any shipping damage. The "Damage and Shortage" instructions packed with the unit outlines the procedure to follow if any parts are missing or damaged.

2.0. DESCRIPTION

2.1. GENERAL

WHR34*S*** Series STABILINE® Automatic Voltage Regulators are three phase, 380Y/220 X 480Y/277 volt, fast acting electromechanical regulators. These WHR Series voltage regulators regulate one line-to-line voltage and correct all phases by the same amount. These voltage regulators are wye connected, have an

analog electronic control section, and have a power section consisting of one or more motor driven limited range POWERSTAT® Variable Transformers. Units with a suffix, starting with a dash, at the end of the model numbers are equipped with standard options. Refer to the WHR model numbering system in the next section for more details. See the enclosed rating charts and unit nameplate for complete specifications.

Advantages of all WHR Series voltage regulators include high efficiency (99% typical), high overload capacity and low impedance. These voltage regulators are insensitive to the magnitude and power factor of the load, and have little to no effect on system power factor. This means these regulators can be used with any type load.

2.2. STANDARD MODEL NUMBER SYSTEM

The model number for each WHR Series voltage regulator identifies the various characteristics of that specific unit. The following table explains the meaning of each character in a standard model number.

Typical Model Number →		W	H	R	S	3	2	W	T	F32	T	-	CB	D	M	T	3	6	7
<input type="checkbox"/>	WHR	Wide Range High Power Regulator																	
<input type="checkbox"/>	S	Transient Voltage Suppression §																	
<input type="checkbox"/>	1	Single Phase (Parallel Connected)																	
<input type="checkbox"/>	2	Single Phase (Parallel Series connected)																	
<input type="checkbox"/>	3	Three Phase (wye in / wye or delta out)																	
<input type="checkbox"/>	6	Three Phase (delta in / delta out) §																	
<input type="checkbox"/>	9	Three Phase (delta in / wye or delta out) w/ zig-zag §																	
<input type="checkbox"/>	1	Nominal Voltage 120-127 (100)																	
<input type="checkbox"/>	2	Nominal Voltage 208 X 220-230-240 (277)																	
<input type="checkbox"/>	4	Nominal Voltage 380-400-415 X 480																	
<input type="checkbox"/>	6	Nominal Voltage 480 X 600																	
<input type="checkbox"/>	N	Narrow Range																	
<input type="checkbox"/>	W	Wide Range																	
<input type="checkbox"/>	S	Single Control																	
<input type="checkbox"/>	D	Double Control																	
<input type="checkbox"/>	T	Triple Control																	
<input type="checkbox"/>	LNN	Size Code (3 or 4 digits)																	
<input type="checkbox"/>	R	Rack Cabinet																	
<input type="checkbox"/>	T	Tall Cabinet																	
<input type="checkbox"/>	CB	Input Circuit Breaker																	
<input type="checkbox"/>	CS	Input Circuit Breaker w/ 120vac Shunt Trip																	
<input type="checkbox"/>	CR	Input Circuit Breaker w/ 120vac Under voltage Trip Release																	
<input type="checkbox"/>	D	Delayed Output																	
<input type="checkbox"/>	M	Manual Bypass Switch																	
<input type="checkbox"/>	T	Tropicalization Treatment																	
<input type="checkbox"/>	0	No Meter Options																	
<input type="checkbox"/>	1	Ammeter(s)																	
<input type="checkbox"/>	2	Frequency Meter w/ Alarm Contacts																	
<input type="checkbox"/>	3	Both 1 & 2 above																	
<input type="checkbox"/>	0	No Alarm Circuit Options																	
<input type="checkbox"/>	4	Input Voltage Range Alarm(s)																	
<input type="checkbox"/>	5	Phase loss/Phase reversal Alarm																	
<input type="checkbox"/>	6	Both 4 & 5 above																	
<input type="checkbox"/>	0	No Miscellaneous Options																	
<input type="checkbox"/>	7	Manual Raise / Lower Switch(s)																	
<input type="checkbox"/>	8	Soft Start																	
<input type="checkbox"/>	9	Both 7 & 8 above																	

§ Base model numbers (no options) as shown in catalog include the characters up to the hyphen (-) with the exclusion of the TVS and Delta options.

- For lettered options not selected the letters and spaces are omitted from the model number.
- The last three numbers in the model number are all used unless all three are zero then they are omitted.

2.3. THEORY OF OPERATION

These units regulate AC voltage by automatically adjusting POWERSTAT® Variable Transformers to maintain constant output voltage.

The solid-state control unit detects one line to line output voltage and continually compares it with output and accuracy settings selected by the user. If line to line voltage is out of specifications, the control unit drives the POWERSTAT variable transformers by means of a synchronous motor, to the required new position.

3.0. INSTALLATION

3.1. TRANSPORTING THE REGULATOR

Due to its weight and size, proper lifting procedures must be followed when transporting the unit and moving it into the location where it is to be installed.

The proper method for moving these units is to place a forklift under the base. A heavy frame is provided in this area to allow lifting the unit in this manner without damage. The 26 inch (559 mm) wide enclosures can also be lifted by removing the top cover and using the lifting eyes provided in the sides of the cabinet.

3.2. MECHANICAL INSTALLATION

The voltage regulator is designed for floor mounting. When mounting the unit, allow a minimum clearance of 4 inches (100 mm) behind the unit for proper ventilation. All internal components and wiring connections are accessible through the front panels. A 3 foot (1000 mm) area in front of the unit should be kept clear for installation and service.

3.3. ELECTRICAL INSTALLATION

All WHR Series voltage regulators are designed to be hard-wired to the input power and the load using copper wire. When these units increase low input voltage to give nominal output voltage, the input current is substantially higher than the output current. Maximum rated input and output currents for each unit are given in the enclosed rating charts. Select a wire size that is adequate to carry the maximum rated current as specified by local and national code requirements.

The front panel(s) of the voltage regulator must be removed to allow access to the input and load terminals. To remove a panel, use a flat blade screwdriver to release the ¼ turn fasteners, which hold the front panel in place, and lift the panel off the base. A full range of knockouts are provided in the base and the rear panel of the unit for wire entry and exit.

The location of the power connections varies depending on the options provided. On units with an input circuit breaker, input connections are made directly to the circuit breaker. On units without any options, the input connections are located on the POWERSTAT variable transformer. The input power connections are labeled L1, L2, and L3 for the three hot lines. Load connections are labeled T1, T2, and T3 for the hot lines and are made to the POWERSTAT variable transformer on units without any options.

In some cases the unit consists of more than one enclosure. In these cases each enclosure will be labeled "L" for input and "T" for output. In installing multiple enclosure units refer to the second page of the schematic supplied for point to point connections.

The input/output neutral is labeled NEUT. The input neutral must be connected unless a zig-zag transformer option is included.

WHR64 and WHR94 series have a zig-zag or neutral generating transformer included. **The input neutral MUST NOT be connected to either of these series units.** The transformer in the WHR64 series is for internal use only and no external neutral should be connected. The zig-zag transformer in a WHR94 series is designed to support the full rated output neutral of the unit.

The ground terminals are a ground stud on the cabinet wall, or a lug on the base, and must be connected to a suitable earth ground to reduce the chance of electrical shock.

4.0. START UP

Set the Output Voltage Range toggle switch on each control module to either the 380 or the 480 volt position to match your application. Use the 380 volt position for 400 and 415 volt systems. The Output Voltage Adjustment and the Sensitivity potentiometers are set at the factory for nominal output voltage and approximately 2% accuracy, and should not be readjusted until the voltage regulator is initially energized.

After all input and output connections are completed and checked, place the front panel(s) in position and tighten the fasteners.

Energize the regulator power source and, if provided, place the voltage regulator's circuit breaker in the "ON" position. The voltmeter should indicate the output voltage (approx. 400 or 460 volts), and the POWER pilot lamps and the CONTROL pilot lamps should be lit. This indicates the voltage regulator is operating properly.

5.0. OPERATION

5.1. CONTROL MODULE ASSEMBLY

5.1.1. General

The control modules contain the circuitry that senses the output voltage and determine if correction is needed. When correction is required this circuit sends a raise or lower signal to the motor driven variable transformers. To eliminate unauthorized tampering of the control module the items marked (♦) below are located behind the front panel.

5.1.2. Power Pilot Lamps (A1-LP1)

The POWER lamp on each control assembly lights when power is present for the motor. This indicates the voltage regulator is energized.

5.1.3. Control Pilot Lamps (A1-LP2)

The CONTROL lamp lights when the control assembly sense voltage is energized. The control sense voltage must be energized for automatic correction of voltage changes to occur.

5.1.4. Analog Voltmeters (A1-M1)

This meter shows the output voltages. The meter senses and displays line-to-line voltage.

5.1.5. Output Voltage Range Toggle Switches (A1-S1)♦

With these switches in the OFF position, the control sense voltage is disconnected and the control pilot lamp is not illuminated. In this position automatic correction for voltage changes will not take place and any change in input voltage will be reflected in output voltage. The switch should be placed in either the "380" or "480" position to energize the control assembly sense voltage and allow automatic correction of voltage changes.

5.1.6. Output Voltage Potentiometers ♦

This potentiometer sets the line to line output voltages. The adjustment range is approximately $\pm 10\%$ of selected nominal output voltage.

5.1.7. Sensitivity Potentiometers ♦

This potentiometer adjusts the voltage regulator's output accuracy and therefore sets how much the output voltage will change before the unit will correct.

5.1.8. Fuses (A1-F1 to A1-F4) ♦

The four fuses located on the control module protect the motor and sense power lines. If the POWER or CONTROL lights are not lit, and all control settings are proper, check for a blown fuse.

5.2. SETTING OUTPUT VOLTAGE AND SENSITIVITY POTENTIOMETERS

Normally, the WHR Series voltage regulator should not be operated without the front panel(s) of the cabinet in place. However, during the initial operation of the regulator, the front panels can be removed to allow setting the OUTPUT VOLTAGE and SENSITIVITY potentiometers.

5.2.1. Energize Regulator

On units equipped with a manual bypass switch ensure it is in the REGULATOR position. Energize the regulator power source and place the input circuit breaker, if so equipped, in the "ON" position. The pilot lamps should light, indicating that the voltage regulator is energized and that the control unit is on. If necessary, move the OUTPUT VOLTAGE RANGE switch to the desired nominal output voltage position. The voltmeters will indicate the output voltages.

5.2.2. Set Output

To adjust the output voltage turn the OUTPUT VOLTAGE potentiometer clockwise to increase or counterclockwise to decrease the output voltage, as indicated on the voltmeter.

5.2.3. Set Sensitivity

The sensitivity must be adjusted if the voltage regulator hunts (the motor driven variable transformer section of the regulator continually cycles back and forth) or if the regulator allows too great a change from the set voltage before correction occurs.

Turning the SENSITIVITY control clockwise increases the sensitivity to maximum ($\pm 0.75\%$ to $\pm 1\%$ output voltage accuracy). For maximum sensitivity, turn the SENSITIVITY control clockwise slowly to the point where the POWERSTAT begins to hunt. Turn the control counterclockwise (CCW) until the hunting stops. Turn the control an additional 1/4 turn CCW.

5.2.4. Close

Replace the front cover(s).

5.3. REMOTE SENSING

Normally, these voltage regulators sense and regulate line to line voltage at the regulator's output terminals. In some cases better control can be obtained by regulating the voltage at another point, such as at the end of long lines between the regulator and the load. This is known as remote sensing.

If remote sensing is desired, move the wire connected to terminal 6 to terminal 7 and the wire connected to terminal 8 to terminal 9 on control module terminal panel. This will disconnect the control module sense terminals from the output terminals of the regulator. Connect remote sensing wires for corresponding line to line voltage to terminals 6 and 8 on the control modules.

6.0. OPTIONS

6.1. NON DESIGNATED OPTIONS

6.1.1. Auxiliary Power Modules (A2)

These modules are provided on units where a 120 volt AC source is required to operate internal circuitry. The output voltage of these modules is on terminals 1 and 2 of the terminal strip. If there is no output on these terminals check the two fuses mounted on the same bracket. The output of the auxiliary power modules are used to operate fans, trip or hold on circuit breakers, and on any other applications where 120 volts is required.

6.1.2. Fans (B2)

On larger units fans are provided to help efficiently remove heat generated in the cabinet. An auxiliary power module supplies the fan operating voltage. If the fans do not operate insure the auxiliary power module output voltage is present.

6.2. MODEL NUMBER SPECIFIED OPTIONS

6.2.1. Circuit Breaker (CB1)

An input circuit breaker provides short circuit and overload protection for the WHR Series Voltage Regulators. Industrial circuit breakers with high interrupting capacity are used. These breakers also serve as an on/off switch for the regulator and any load attached.

6.2.1.1. Shunt Trip (L1)

In unit where the model number designates the input circuit breaker as "CS" the circuit breaker is equipped with a shunt trip. A shunt trip causes the breaker to open when voltage is applied to the shunt trip coil. The trip coil is rated 120 volt, AC and is de-energized when the breaker opens.

When alarm contact options and a circuit breaker trip option are ordered together, the unit is furnished with 120 volt AC, auxiliary power module (A2) and the alarm circuit contacts are wired to trip the input breaker. The Shunt Trip Connections Diagram shows the typical connections.

6.2.1.2. Under Voltage Trip (L1)

In unit where the model number designates the circuit breaker as "CR" the circuit breaker is equipped with an under voltage release coil. This coil allows the circuit breaker to close when voltage is applied and opens the breaker if the coil voltage is lost. The trip coil is rated 120 volt, AC. The coil voltage must be present in order to close the circuit breaker.

6.2.1.3. Circuit Breaker Trip Coil & Alarm Contacts

When alarm contact options and a circuit breaker trip option are ordered together, the unit is furnished with 120 volt AC, auxiliary power module (A2) and the alarm contacts are wired to trip the input breaker. A momentary switch is provided to override any alarm activation that would trip the circuit breaker. This allows turn on of the system and alarm options to reset. Hold switch in while turning on the circuit breaker. Alarm options include frequency meter, input voltage range alarm, and phase loss / phase reversal alarm.

The following connection diagrams show typical shunt trip and under voltage release circuits.

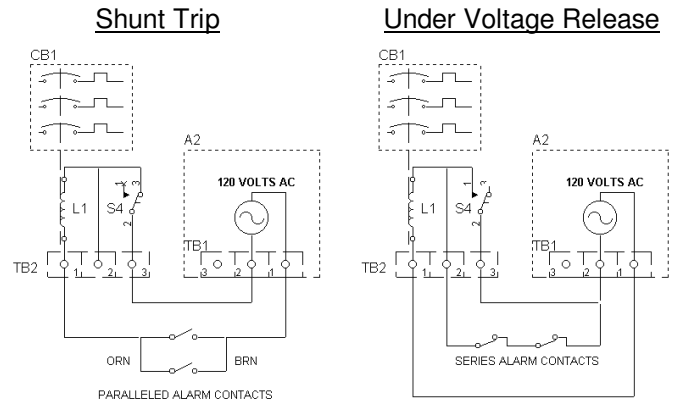

If you do not want the alarm contacts to trip the input breaker, the unit can easily be re-configured.

Disable the alarms from tripping a shunt trip coil, remove the 120 volts supplied by the auxiliary power module to energize the coil. Removing the wires from A2-TB1 terminals 1 and 2 that connect to the alarm switches and TB2 does this. Do not disconnect any other devices from this source.

Disable the alarms from tripping an under voltage trip coil, by supplying the 120 volts directly to the coil without going through the alarm contacts. Move the wire on TB2-3 that comes from the auxiliary power module to TB2-2 to accomplish this.

6.2.2. Delayed Output (A5, K2)

The delayed output option allows time for the power to stabilize before energizing the load. This is accomplished by adding a contactor and timer to the regulator. When the regulator is initially energized: the timer starts. After the preset time delay the contactor automatically closes energizing the load. The time delay is field adjustable from approximately 5 to 30 seconds and factory adjusted to approximately 10 seconds when shipped.

6.2.3. Manual Bypass Switch (S3)

This two-position switch, in the REGULATOR position, provides conditioned power from input source through the regulator to the load. In the BYPASS position the input power and load are disconnected from the regulator's circuits and connects together directly. THIS IS A NON-LOAD BREAK SWITCH AND INPUT POWER MUST BE OFF BEFORE OPERATING. On three phase units the neutral is not switched.

Caution: This switch is designed to provide unconditioned power to the load if a fault condition occurs. **It does not remove all live power from the enclosure.** The manual bypass switch does not bypass the input circuit breaker or zig-zag transformer if so equipped.

6.2.4. Ammeters (M1)

An analog ammeter displays load current for each phase. Each meter indicates the load current within 2% of the meters full range.

6.2.5. Frequency meter with alarm contacts (M2)

Frequency meter displays the source frequency and provides alarm contacts for values outside the user's settable limits. Lower and upper limit trip relays are factory set at 45 Hz and 65 Hz respectively. If the frequency becomes lower or higher than user selected values, an output relay is energized. The relay is equipped with a form "C" normally open / normally closed contact available for customer use.

If a circuit breaker with a trip coil is ordered with the frequency meter, the system is configured to automatically trip the breaker when a limit is exceeded.

6.2.5.1. Frequency Meter Instructions

The frequency meter owner's manual is included with the literature sent with the unit. The user can change the meters setting without storing them in memory. If the user changed the factory settings, and did not select the store option, the factory setting can be reinstated by pressing both RECALL buttons at the same time. The stored factory settings are shown in the table below.

To return the stored settings to the factory default, tap the ENTER key to go to the next feature then use SET and ADVANCE keys to change the setting to those shown below. When the display shows Store, tap the Enter key to lock the setting into memory. If no other setting was stored after this procedure, pressing both RECALL keys will return the meter to these settings.

Feature	Setting	
Func	Freq	
Scale	A / SC	2.00000
Offset	000000.	
Range	FFFF.FF	
Slope	A Pos	
Sp lo	000045	
Sp hi	000065	
Gate t	01.30	
Conf 1	no setting required	
Conf 2	no setting required	
No store	Store	

A front and rear view of the frequency meter is shown below with the N.O. alarm contacts in parallel. The alarm contacts are connected to TB4 as follows:

- 1 – HI relay Com
- 2 – HI relay N.O.
- 3 – HI relay N.C.
- 4 - LO relay COM
- 5 - LO relay N.O.
- 6 - LO relay N.C.

Frequency Meter

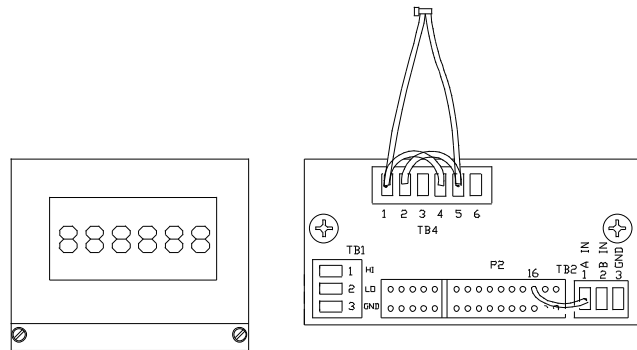

6.2.6. Input Range Alarm (K1)

Input voltage range alarm closes a N.O. solid state contact when the regulator is providing maximum voltage correction. This option senses regulator motor drive end of travel limit switch operation.

6.2.7. Phase Loss, Phase Reversal Alarm Contacts (A3)

Provided for three phase units only, this option senses the three phase voltage and operates a relay (form "C" normally open / normally closed contact) when any phase voltage is lost, or if the voltage sequence of the power is reversed.

If an input circuit breaker with a shunt trip is ordered, the system is configured to automatically trip the breaker when there is a phase reversal. The system might not trip the breaker when there is a phase loss because power to operate the shunt trip may not be available.

Alarm circuit contacts provided with the Frequency Trip Meter, Input Voltage Range Alarm and Phase Loss - Phase Reversal options are rated 5 amps 240 volts AC.

6.2.8. Manual Raise / Lower Switches (A1-S2 & A2-S3)

Manual raise / lower switches allow the user to disable the automatic control unit and manually raise or lower the output voltage using the motor drive. The man/auto switch must be in the manual position for the raise/lower switch to operate.

6.2.9. Soft Start

The soft start option controls the WHR Series Voltage Regulator so that when power is applied the regulator's output voltage starts out approximately 10% low and after a preset time delay, the output voltage ramps up to the selected regulated output voltage.

When input power is lost, the soft start controls automatically drives the POWERSTAT power module(s) to the minimum output voltage position using the output power from a small uninterruptible power supply (UPS). The UPS then turns off automatically. For UPS care and maintenance see the UPS manual.

When regulator power is restored, the load voltage will be approximately 7% less than the input voltage on narrow range WHR Regulators and 13% less than the input voltage on wide range models. After a short time delay, the regulator output voltage ramps up to the selected, regulated output voltage.

6.3. ALL-BUCK AND ALL-BOOST OPERATION

All WHR Series regulators can be connected to provide all-buck (unit will only lower the input voltage) or all-boost (unit will only increase the input voltage) operation. This feature can be used to shift the nominal voltage or to correct input voltages that are always extremely high or extremely low.

6.3.1. 4.4.1 All-Boost Operation

When connected for all-boost, the units will bring extra low voltages up to nominal, but will not correct high input voltages. Since operation in the all-boost mode will increase the voltage and heating in the WHR regulator, the rated load current, and in some cases the maximum rated nominal input voltage, must be reduced. Refer to the "All Buck and All Boost Rating Chart" for the all-boost ratings. For all-boost operation the input line to each POWERSTAT variable transformer must be moved from terminal 2 to terminal 5.

6.3.2. 4.4.2 All-Buck Operation

When connected for all-buck operation, the units will bring extra high input voltages down to nominal, but will not correct low input voltages. Since all-buck operation reduces the voltage in the regulator, the nominal input voltage can be increased. The current ratings remain the same. Refer to the "All Buck and All Boost Rating Chart" for all-buck ratings. All-buck operation requires moving the input line to each POWERSTAT Variable Transformer from terminal 2 to terminal 4.

All Buck and All Boost Rating Chart

Standard Rating		All Buck Operation				All Boost Operation				
		(max output voltage = input voltage)				(min output voltage = input voltage)				
		Maximum Nominal Input Voltage	§ Minimum Output Voltage (% of Input)	† High Input Voltage Range (% of Output)	Maximum Nominal Input Voltage	§ Maximum Output Voltage (% of Input)	‡ Low Input Voltage Range (% of Output)	Current De-rating (% of rated)		
50 Hz	60 Hz								50 Hz	60 Hz
Voltage	Range	50 Hz	60 Hz			50 Hz	60 Hz			
380 X 480	Narrow	480	550	80%	125%	345	415	125%	75%	77%
	Wide	520	600	67%	150%	345	415	150%	65%	72%

§ Selectable output voltage is a function of the control module and must remain within the limits specified in the unit rating charts.

† In all buck operation the input voltage range is from the selected output voltage to the 'high input voltage range'.

‡ In all boost operation the input voltage range is from the 'low input voltage range' to the selected output voltage.

7.0. MAINTENANCE

To ensure maximum life of the equipment, the following should be part of an **annual** maintenance program.

Warning

De-energize unit before performing maintenance. Voltages are present inside this unit which can cause injury. Therefore, only personnel qualified to service electrical equipment should perform maintenance on this unit.

7.1. Vacuum the voltage regulator inside and out to remove accumulated dirt, which could lead to overheating or insulation failure.

7.2. Tighten all electrical connections, particularly all power wiring to, and in, the unit.

7.3. Inspect all variable transformer brushes and commutators for signs of wear or pitting. Replace as required. See diagram below.

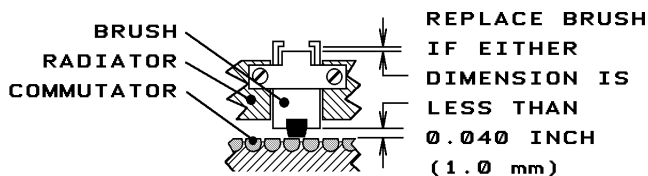

Do not attempt to clean a commutator with an abrasive such as sandpaper or a file. This will ruin the soft precious metal plating on the commutator and will shorten the life of the unit. It is normal for commutators to become black due to carbon brush tracking. If a commutator is to be cleaned, use denatured alcohol and a soft cloth.

7.4. Inspect the variable transformer drive belts, sprockets, gears, cams, etc. for signs of slippage or wear and adjust as required.

7.5. Check the variable transformer radiator(s) (the die cast part that holds the brush assembly) for signs of slippage, and see if all brushes driven by the same motor are aligned with each other. The alignment of the radiator and brushes depends on the setscrews that hold the variable transformer center tube(s) to the shaft and the setscrews that hold the radiator to the center tube. Adjust and tighten as needed.

7.6. Lubrication of the WHR Series voltage regulator is not required since it has been lubricated at the factory for its lifetime.

8.0. TROUBLESHOOTING

WHR Series voltage regulators will provide long, reliable service with little attention. Unless the unit is overloaded, there is little likelihood of component failure.

Warning

Voltages are present inside this unit which can cause injury. Therefore, only personnel qualified to service electrical equipment should perform trouble-shooting procedures on this unit.

If the regulator fails to operate correctly, the following checks will help locate and correct the problem. Refer to the schematic, rating chart and replacement parts list for further information.

8.1. Check the load connected to the voltage regulator to be sure the unit's output current rating is not being exceeded.

8.2. See if the POWER pilot lamps are on. If a lamp is not on, there is no power to the voltage regulator, or control module fuses F1 and F2 (POWER fuses) are blown, or the lamp has burned out. Check the POWER fuses (F1 and F2). Check the power input to the unit to be sure the voltage is within the range specified for the selected output voltage.

8.3. Check the output voltmeters. If a meter shows zero output voltage, check the input line, control module fuses F3 and F4 (CONTROL fuses), remote sense wiring if applicable, and input connections. If so equipped, check position of input circuit breaker and manual bypass switch.

8.4. Check the CONTROL pilot lamps. If one is not lit, check it's VOLTAGE RANGE switch to be sure it is on and check for blown CONTROL fuses (F3 and F4). If applicable, check the remote sense wiring.

8.5. If the motor hunts (cycles continuously), readjust the SENSITIVITY control.

8.6. If a motor drives a POWERSTAT variable transformer to one end of its travel, and the voltage decreases when it should increase or increases when it should decrease, check to see if the input and output power connections to the voltage regulator are reversed. If applicable, check the remote sense wiring.

8.7. If the unit has been reworked or repaired, check to see if the leads driving the motor have been reversed. A1-TB1-2 and A1-TB1-3 provide the motor power to lower and raise the motor with A1-TB1-1 being the common for both AC voltages.

8.8. If the motor continues to hum or buzz after the OUTPUT VOLTAGE RANGE switch is turned off, the solid-state switch controlling the motor may be defective. De-energize the input line to the voltage regulator, and replace the control board.

8.9. If the motor has driven to one end or does not drive at all, check to ensure the motor drive is functioning correctly. Refer to the unit's schematic diagram to complete the following steps:

De-energize the input line to the voltage regulator; place the OUTPUT VOLTAGE RANGE switch in the center (off) position, and remove POWER fuses F1 and F2 on each control module.

Apply 115 volts AC between terminals A1-TB1-1 and A1-TB1-2 on the control module, or to the corresponding terminals at the motor board terminal strip (TB1). These nine junction terminal strips are connected point-for-point. The motor should turn the variable transformer counter clockwise (viewed from top) so as to lower the output voltage until it reaches the end of its travel, where the limit switch will prevent further rotation in that direction.

Apply 115 volts between terminals A1-TB1-1 and A1-TB1-3 should run the motor in the opposite direction until a limit switch stops the motor at the end of travel.

If the motor operates successfully in this test the problem may be with the control board.

8.10. Inspect the POWERSTAT Variable Transformer brush(es) and commutator(s) for signs of wear or damage. The brush assemblies on the variable transformer section will not need replacement under normal conditions. When excessive brush wear or commutator damage occurs, it is usually the result of an overload. If either condition exists, the POWERSTAT Variable Transformer section or the brush must be replaced or repaired. Check the load to be sure the output current rating of the voltage regulator is not being exceeded.

Do not attempt to clean a commutator with an abrasive such as sandpaper or a file. This will ruin the soft precious metal plating on the commutator surface and will shorten the life of the unit. It is normal for commutators to become black due to carbon brush tracking. If a commutator is to be cleaned, use denatured alcohol and a soft cloth.

8.11. Check the variable transformer radiator(s) (the die cast part that holds the brush assembly) for signs of slippage, and see if all brushes driven by the same motor are aligned with each other. The alignment of the radiator and brushes depends on the setscrews that hold the variable transformer center tube(s) to the shaft and the setscrews that hold the radiator to the center tube. Adjust and tighten as needed.

9.0. RATING

9.1. POWER RATINGS

The WHR34*T*** Series ratings are shown below:

INPUT:

VOLTAGE: 380Y/220 X 480Y/277
 FREQUENCY: 50/60 Hz X 60 Hz
 CONNECTION: 3 Phase, 4 Wire, Wye
 RANGE: -30% to +15% of Selected Output

OUTPUT:

VOLTAGE: 380Y/220 X 480Y/277
 CONNECTION: 3 Phase, 3 or 4 Wire

Model Number (base unit)	Rated Load			Max. Input Amps
	Amps	kVA at		
		380 V	480 V	
WHR34WST13	36	24	30	50
WHR34WST16	72	47	60	100
WHR34WST33	108	70	90	150
WHR34WST34	145	95	120	200
WHR34WST35	180	110	150	250
WHR34WST36	215	130	175	300
WHR34WST37	250	150	200	350
WHR34WST38	285	175	225	400
WHR34WST39	325	200	250	450

INPUT:

VOLTAGE: 380Y/220 X 480Y/277
 FREQUENCY: 50/60 Hz X 60 Hz
 CONNECTION: 3 Phase, 4 Wire, Wye
 RANGE: -20% to +10% of Selected Output

OUTPUT:

VOLTAGE: 380Y/220 X 480Y/277
 CONNECTION: 3 Phase, 3 or 4 Wire

Model Number (base unit)	Rated Load			Max. Input Amps
	Amps	kVA at		
		380 V	480 V	
WHR34NSR31	15	10	13	20
WHR34NSS31	28	18	23	35
WHR34NST31	65	43	54	80
WHR34NST32	130	85	105	160
WHR34NST33	195	125	160	240
WHR34NST34	260	170	215	320
WHR34NST35	325	210	270	400
WHR34NST36	390	250	325	480
WHR34NST37	450	300	375	560
WHR34NST38	520	325	425	640
WHR34NST39	580	375	475	720

9.2. VOLTAGE RANGE CHART

At the very extremes of the input range the output voltage may become slightly higher or lower than would

otherwise be the case. This voltage range chart shows the output voltages produced over the input range.

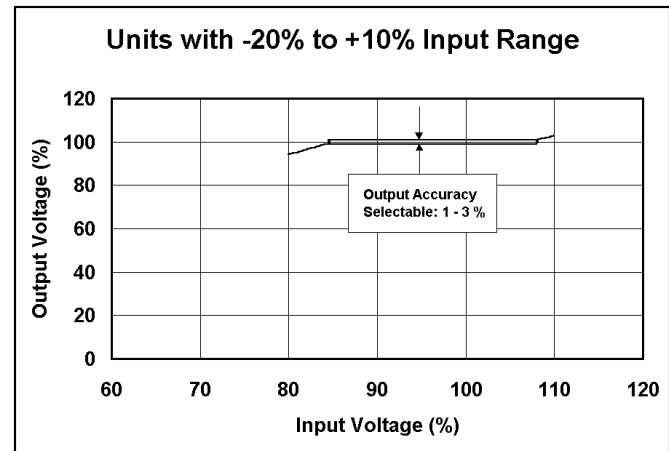
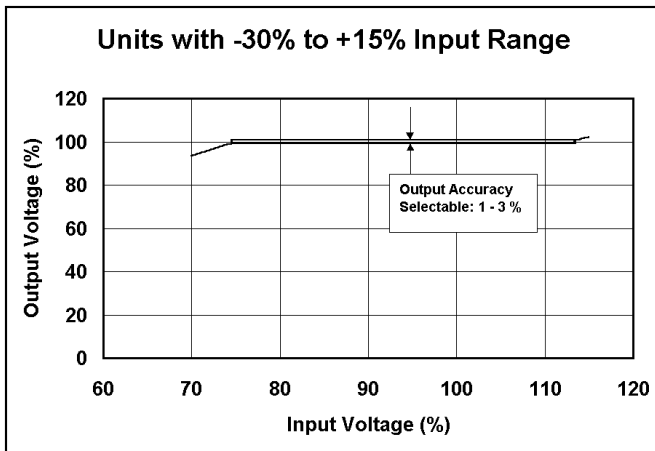

9.3. GENERAL SPECIFICATIONS

Electrical:

Output Accuracy	Adjustable from 1% to 3%
Response Time	0.025 seconds at 60 Hz, 0.030 seconds at 50 Hz
Load Capacity	100% rated continuous 200% rated 60 seconds 400% rated 3 seconds 600% rated 1 second 800% rated 0.5 second 1000% to 2500% 1/2 cycle inrush
Load Power Factor	0 lagging to 0 leading
Load Crest Factor	6 Max (I peak / I RMS)
Efficiency	99% typical, at full load
Heat Generated	BTU (typical) = 35 x rated kVA
Harmonic Distortion	Less than 1% added
Surge Withstand Capability	6000 volts per IEEE C62.41, location category B
Impedance	1% (typical) without transient suppression option 2% (typical) with transient suppression option
Transverse-Mode Noise Attenuation	40 dB (typical) with transient suppression option

Environmental:

Service Conditions	Units are housed in NEMA 1 ventilated enclosures, intended for indoor use under usual service conditions.									
Temperature	Average ambient temperature for any 24 hour period not to exceed 30°C (86°F), and maximum temperature not to exceed 40°C (104°F). Average ambient temperature for any 24 hour period may be increased to 40°C (104°F), and the maximum temperature may be increased to 50°C (122°F), if the load is decreased to 90% of standard rating. Minimum temperature is 0°C (32°F).									
Operating										
Storage	-40°C to +70°C (-40°F to +158°F)									
Humidity (Operating and Storage)	10 to 75% average relative humidity for any 7 day period, and maximum relative humidity not to exceed 95% non-condensing.									
Units without tropicalization										
Units with tropicalization	10 to 95% average relative humidity and maximum relative humidity not to exceed 95% non-condensing.									
Altitude										
Operating	<table border="1"> <thead> <tr> <th>Maximum Altitude</th> <th>Derating</th> </tr> </thead> <tbody> <tr> <td>6,600 Ft.(2,000 meters)</td> <td>No de-rating</td> </tr> <tr> <td>10,000 Ft.(3,000 meters)</td> <td>load to 95%, ambient 30°C (86°F)</td> </tr> <tr> <td>15,000 Ft.(4,500 meters)</td> <td>load to 90%, ambient 20°C (68°F)</td> </tr> </tbody> </table>	Maximum Altitude	Derating	6,600 Ft.(2,000 meters)	No de-rating	10,000 Ft.(3,000 meters)	load to 95%, ambient 30°C (86°F)	15,000 Ft.(4,500 meters)	load to 90%, ambient 20°C (68°F)	
Maximum Altitude	Derating									
6,600 Ft.(2,000 meters)	No de-rating									
10,000 Ft.(3,000 meters)	load to 95%, ambient 30°C (86°F)									
15,000 Ft.(4,500 meters)	load to 90%, ambient 20°C (68°F)									
Storage	50,000 Ft.(15,000 meters)max									

10.0. REPLACEMENT PARTS

10.1. ORDERING

Because this manual covers a full series of units it is impractical to provide a full list of replacement parts. To order a part not listed in this manual, provide the unit model number, serial number, and date code. Reference the part by schematic reference symbol, description and part number if available.

10.2. CONTROL MODULE ASSEMBLY

The same control modules are used throughout this standard WHR Series STABILINE® Automatic Voltage Regulators and are shown below. **Tropicalized units** have a similar control module but some of the parts are specially treated and therefore have a **different part number**.

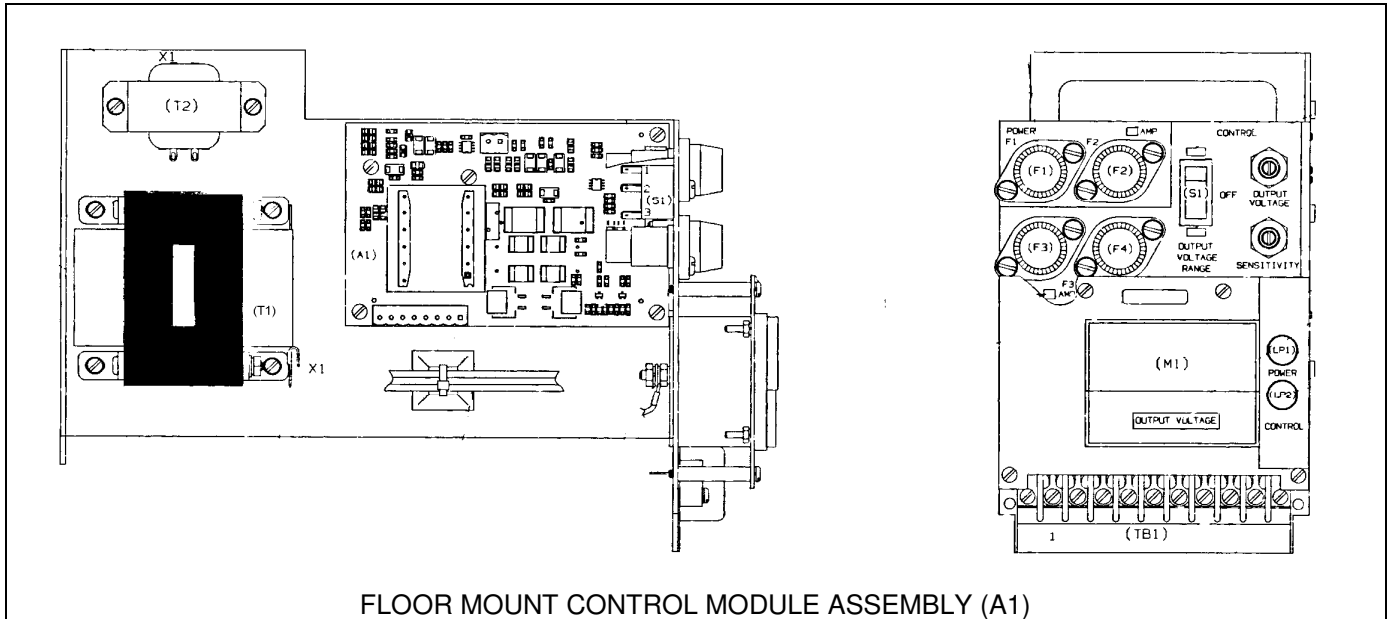

Reference Symbol	Part Description	Standard Part Number	Tropicalized Part Number
A1	CONTROL MODULE	213244-006	213244-010
A1-A1	CONTROL BOARD	227412-001	227412-001-SM
A1-F1,F2,F3,F4	FUSE, 600V	213274-001	
A1-LP1,LP2	LIGHT, INDICATOR, GREEN	227571-001	
A1-M1	VOLTMETER	212917-005	
A1-S1	SWITCH, ROCKER SPDT ON/OFF/ON	227572-001	
A1-T1	TRANSFORMER, POWER	227602-001	
A1-T2	TRANSFORMER, SENSE	227587-001	

ITEMS LISTED BELOW ARE FOR UNITS WITH MANUAL RAISE/LOWER OPTION

A1	CONTROL MODULE WITH R/L OPTION	217748-005
A1-S2	SWITCH, ROCKER ON/ - /ON	227572-002
A1-S3	SWITCH, ROCKER (MOM)	227572-003

10.3. POWER COMPONENTS

The following parts differ depending on the model. Part number can be determined by the letter designations for range and size code in the base model number. Ex. WHR34WST33

Standard Unit		Part Number for Range & Size Code letters listed			
Reference Symbol	Part Description	WST	NSR	NSS	NST
T1	POWERSTAT, VARIABLE TRANSFORMER	212995-002	216971-002	216975-002	212995-003
	REPLACEMENT BRUSH ASSEMBLY	017702-003	176012-002	017702-004	017702-011
T2	CHOKE, PARALLELING	005587-000	None	None	006724-000

Tropicalized Units only ...		Part Number for Range & Size Code letters listed			
Reference Symbol	Part Description	WST	NSR	NSS	NST
T1	POWERSTAT, VARIABLE TRANSFORMER	218312-015	218312-006	218312-012	218312-016

10.4. REPLACEMENT BRUSH ASSEMBLY

Each POWERSTAT® Variable Transformer contains a durable brush assembly. These assemblies are designed to reduce the need for attention or replacement; however, because these are moving parts that rely on contact friction to operate properly, an annual inspection is suggested. Refer to the maintenance section of this manual for details. The replacement brush assembly is listed along with its corresponding POWERSTAT Variable Transformer in the power component section.

10.5. AUX POWER MODULE

There are two standard power modules used throughout this WHR Series of STABILINE® Automatic Voltage Regulators. One is used for Line to Line connections and the other for Line to Neutral connection.

Reference Symbol	Part Description	Line-Line	Line-Neut.
		Part Number	Part Number
A2	CONTROL POWER MODULE	217487-003	217487-002
A2-F1,F2	FUSE	213274-001	104364-003
A2-T1	TRANSFORMER, POWER	227608-001	227602-001

11.0. SCHEMATIC (For reference only, use full size supplied with unit)

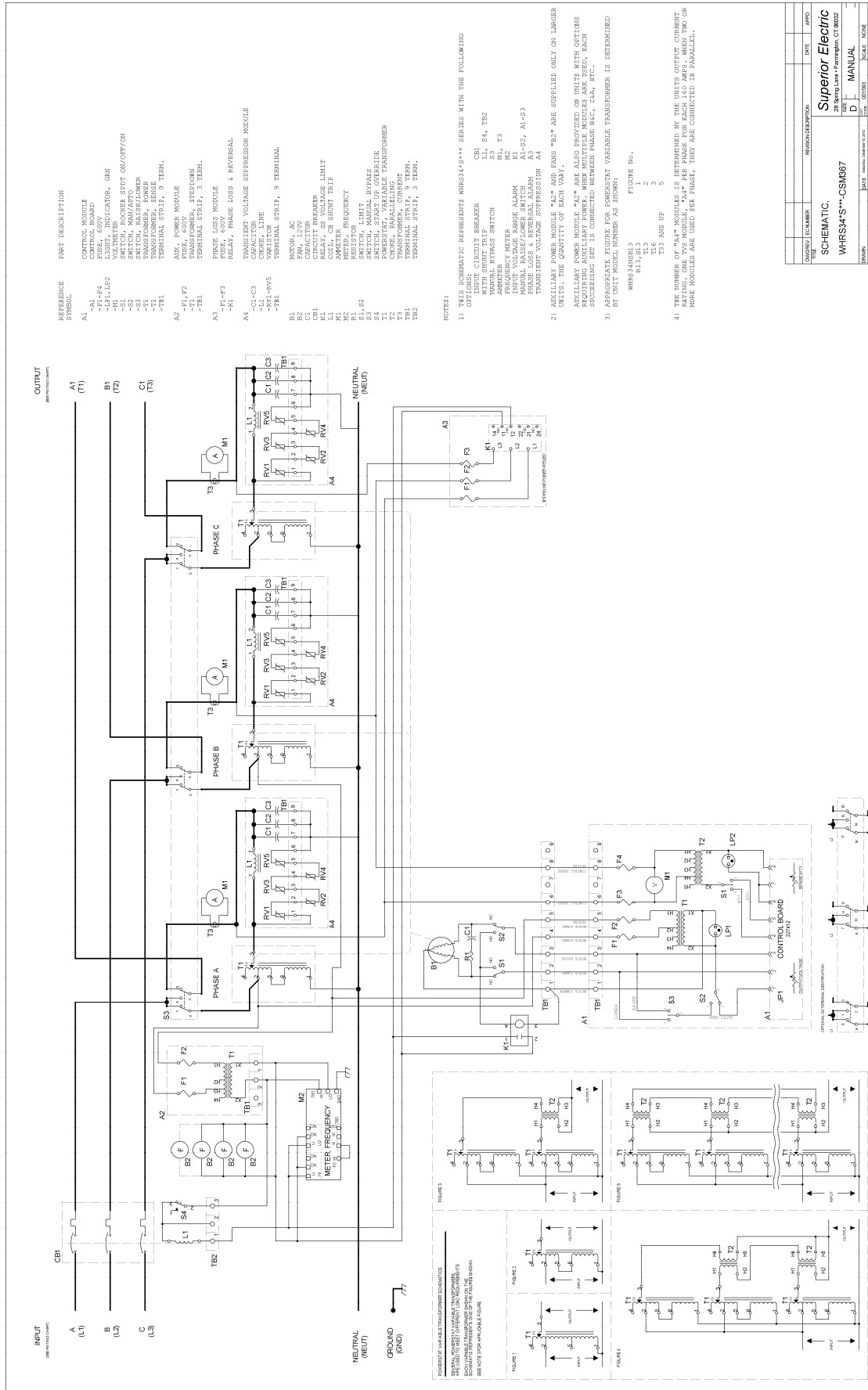

12.0. FLOOR MOUNT DIMENSIONS

Enclosures A through G

Note: All dimensions are inches [millimeters]

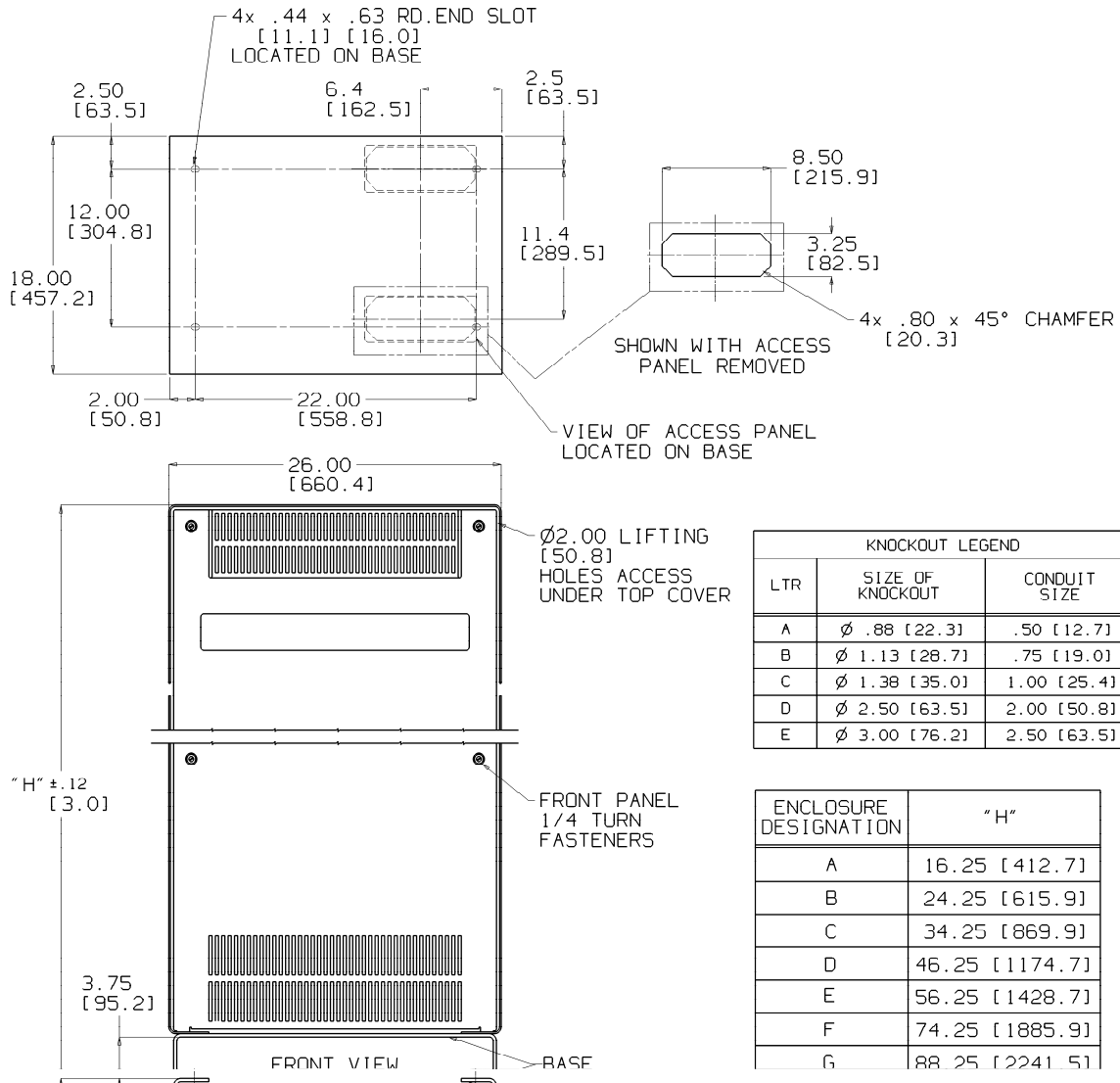

Enclosures A through G continues
 Note: All dimensions are inches [millimeters]

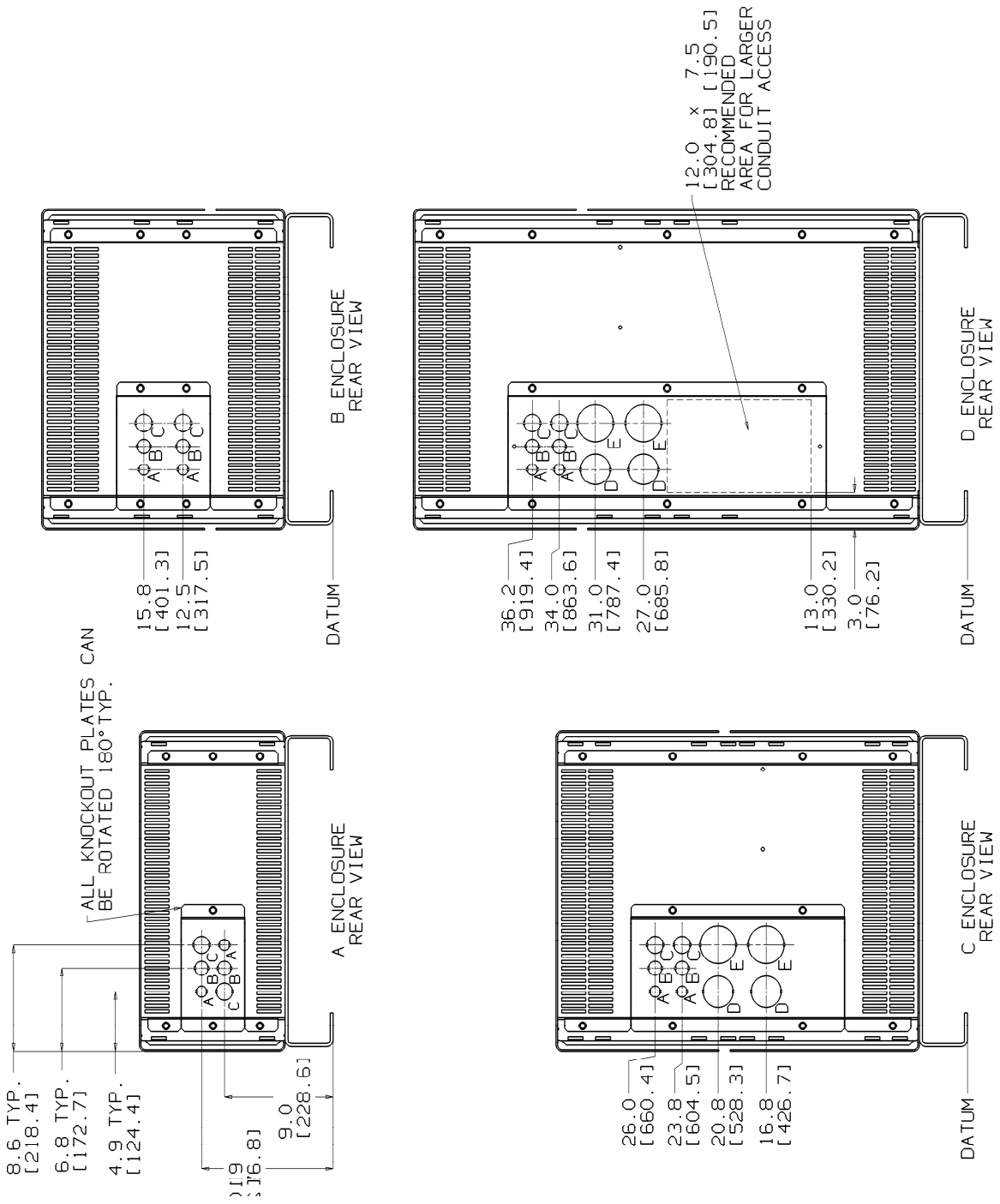

Enclosures A through G continues

Note: All dimensions are inches [millimeters]

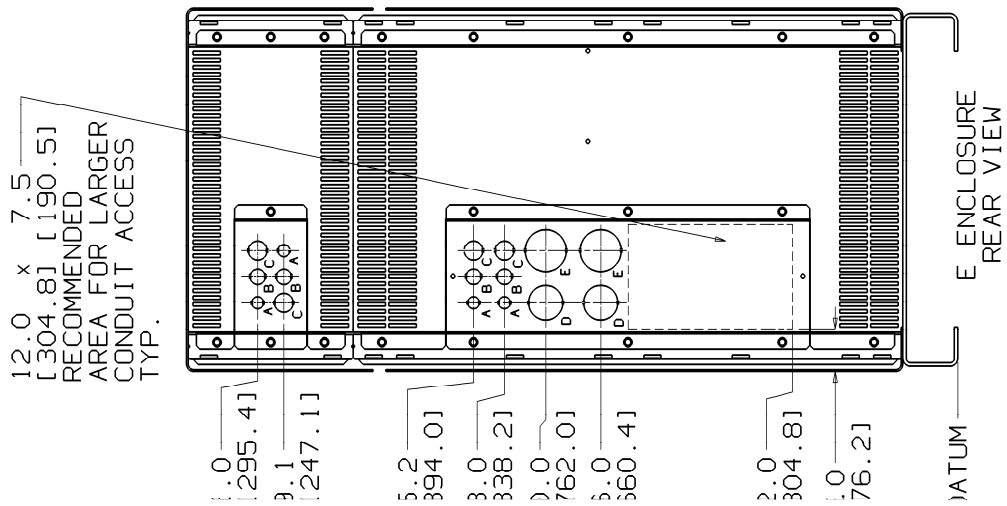
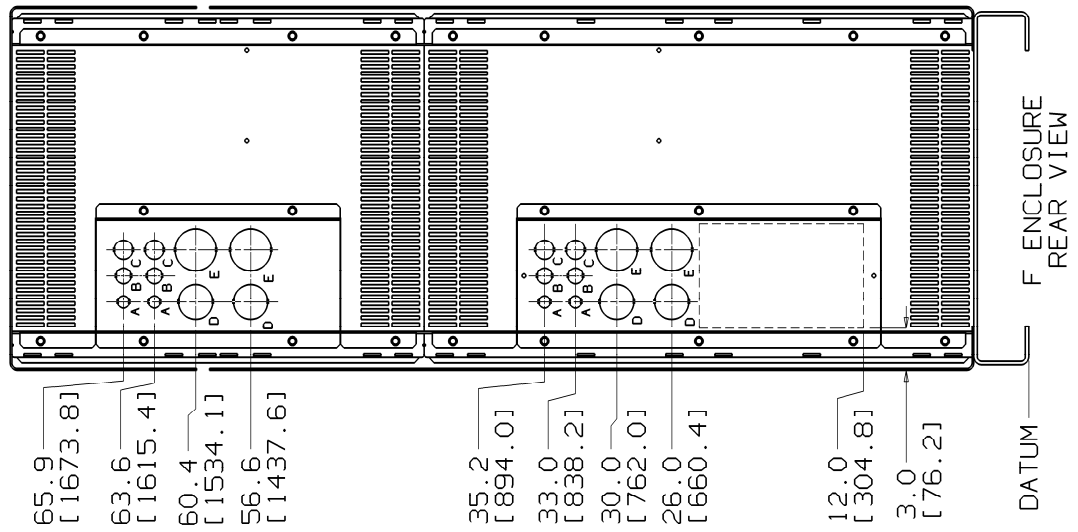
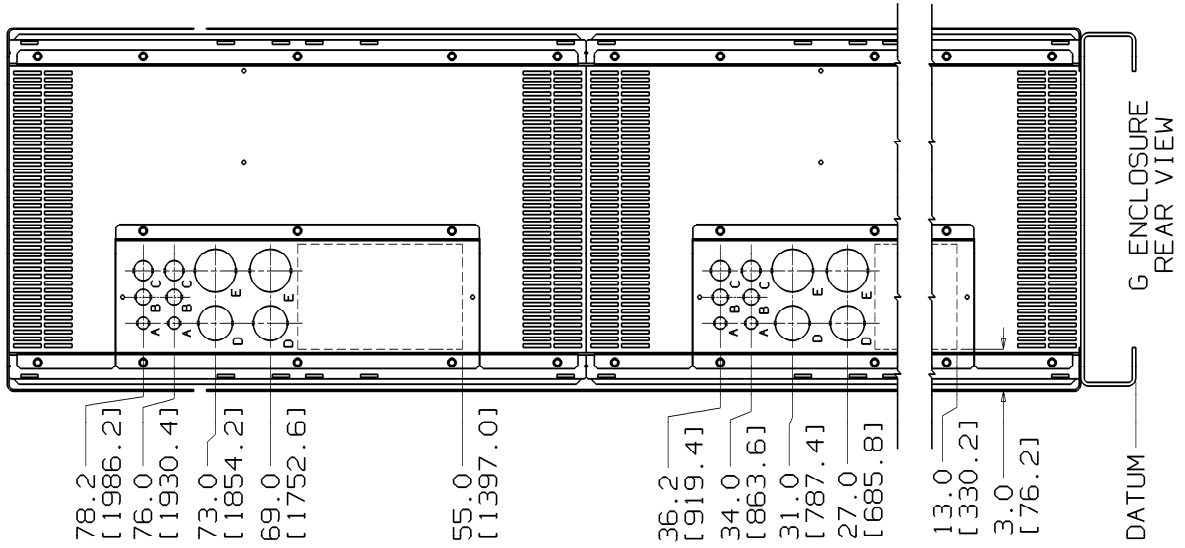

Enclosures DPLUS through GPLUS

Note: All dimensions are inches [millimeters]

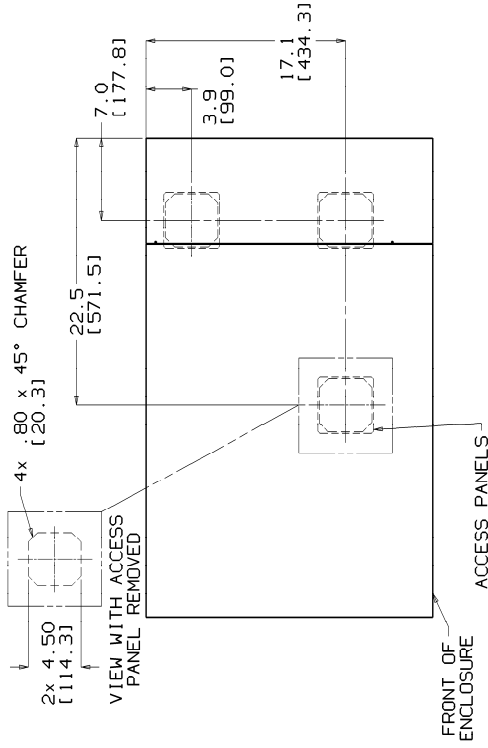

TOP VIEW OF ACCESS PANELS LOCATED ON BASE
BOTTOM WIRING

KNOCKOUT LEGEND		
LTR	SIZE OF KNOCKOUT	CONDUIT SIZE
A	Ø .88 [22.3]	.50 [12.7]
B	Ø 1.13 [28.7]	.75 [19.0]
C	Ø 1.38 [35.0]	1.00 [25.4]
D	Ø 2.50 [63.5]	2.00 [50.8]
E	Ø 3.00 [76.2]	2.50 [63.5]

ENCLOSURE DESIGNATION	"H"
DPLUS	46.25 [1174.7]
EPLUS	56.25 [1428.7]
FPLUS	74.25 [1885.9]
GPLUS	88.25 [2241.5]

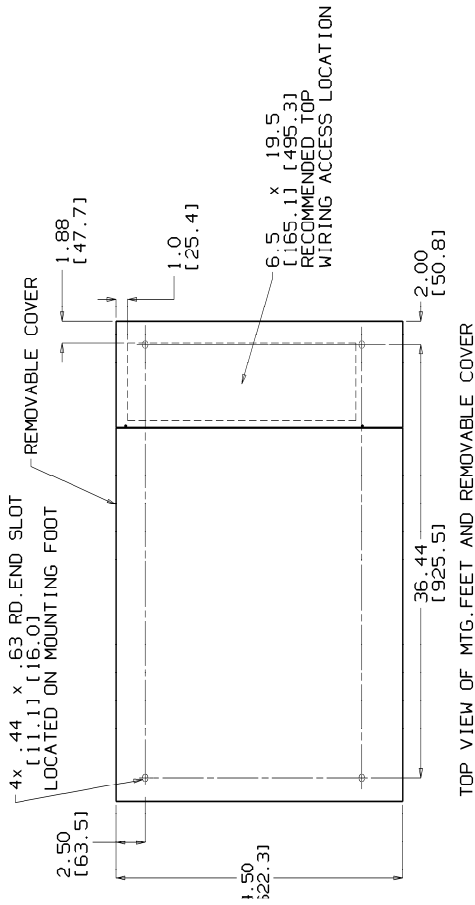

TOP VIEW OF MTG. FEET AND REMOVABLE COVER

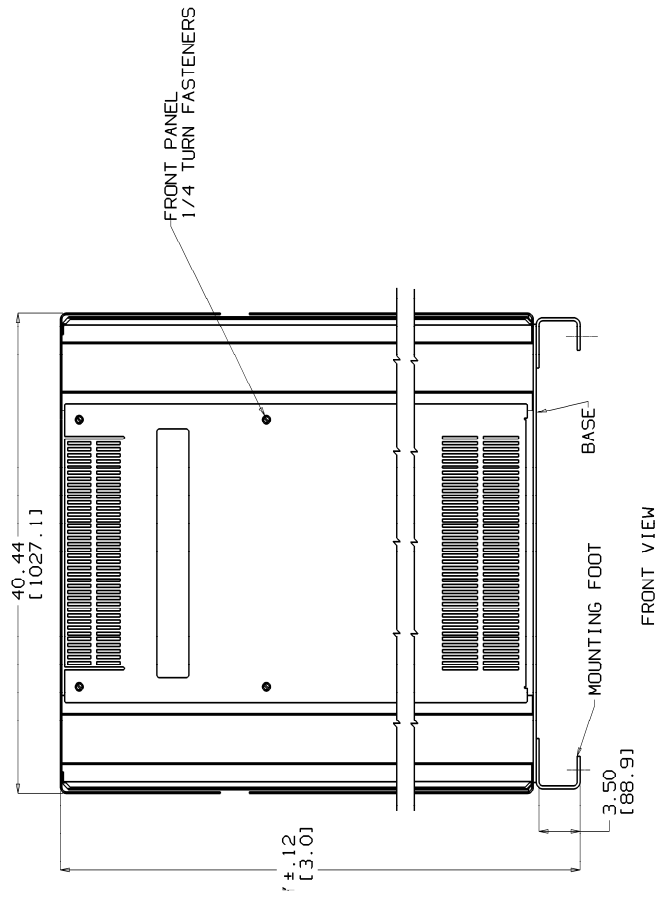

FRONT VIEW

Enclosures DPLUS through GPLUS continues

Note: All dimensions are inches [millimeters]

LTR	ENCLOSURE	
	DPLUS	EPLUS
"F"	27.0 [685.8]	37.0 [939.8]
"G"	31.0 [787.4]	41.0 [1041.4]
"H"	34.0 [863.6]	44.0 [1117.6]
"J"	36.2 [919.4]	46.2 [1173.4]

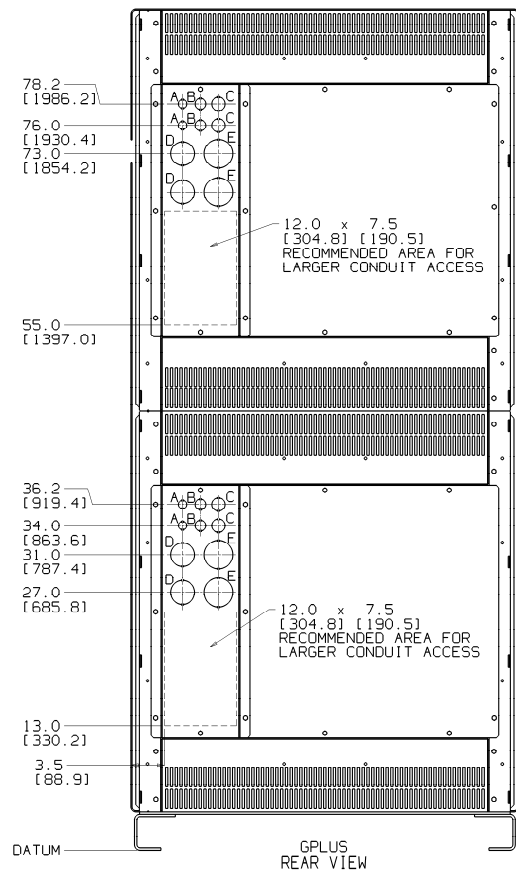
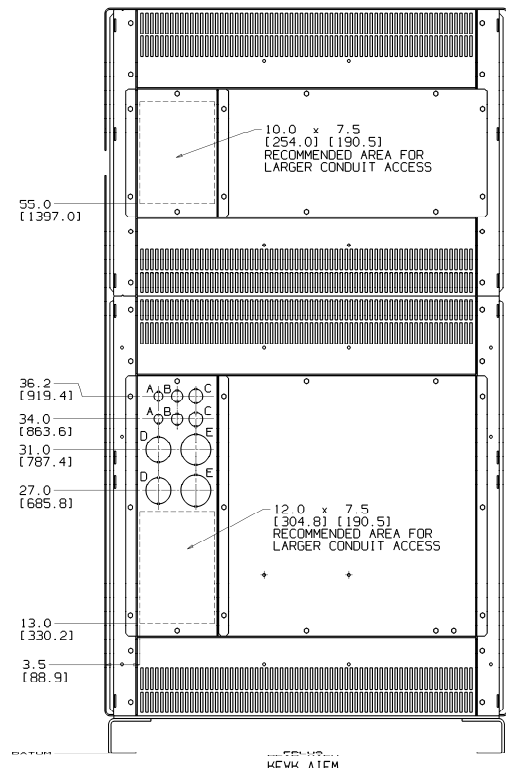
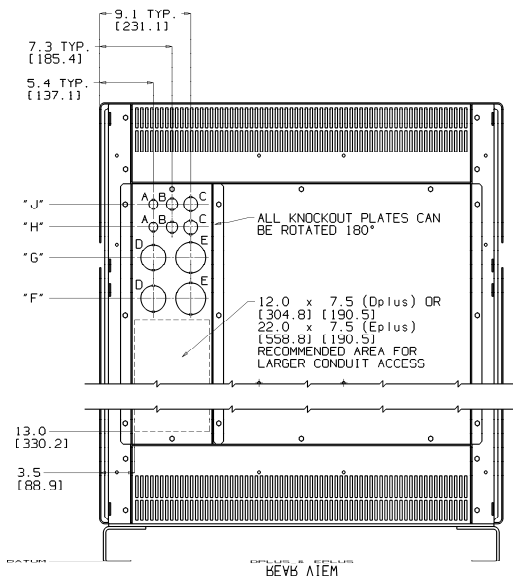

Enclosures DD through GG

Note: All dimensions are inches [millimeters]

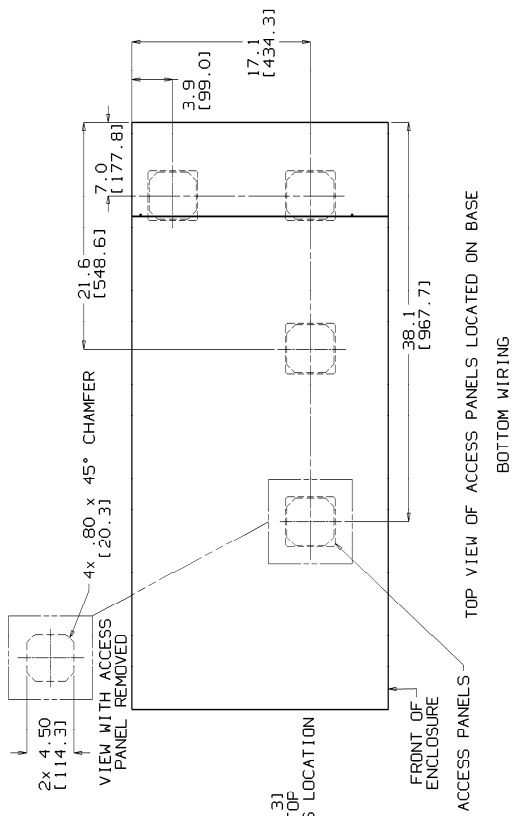

KNOCKOUT LEGEND		
LTR	SIZE OF KNOCKOUT	CONDUIT SIZE
A	∅ .88 [22.3]	.50 [12.7]
B	∅ 1.13 [28.7]	.75 [19.0]
C	∅ 1.38 [35.0]	1.00 [25.4]
D	∅ 2.50 [63.5]	2.00 [50.8]
E	∅ 3.00 [76.2]	2.50 [63.5]

ENCLOSURE DESIGNATION	"H"
DD	46.25 [1174.7]
EE	56.25 [1428.7]
FF	74.25 [1885.9]
GG	88.25 [2241.5]

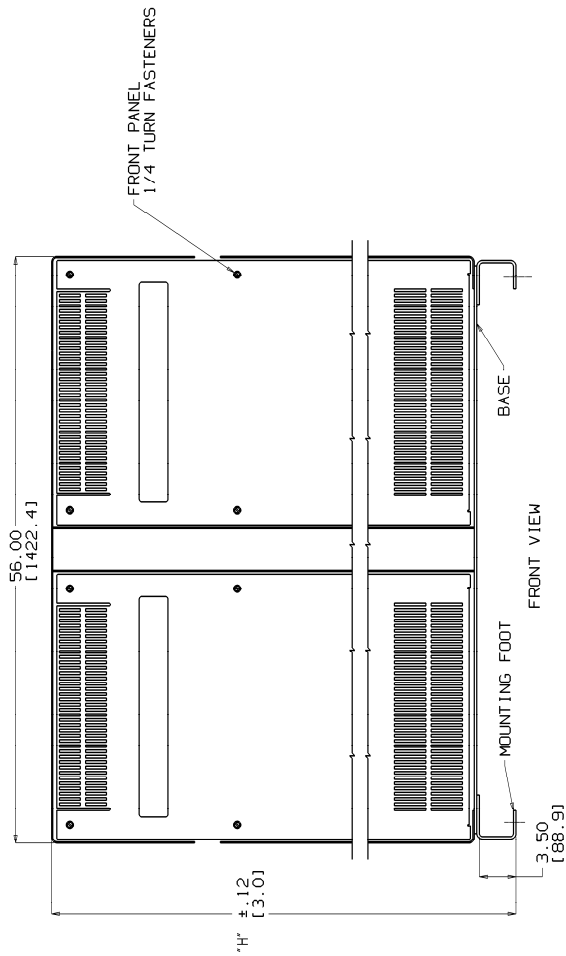
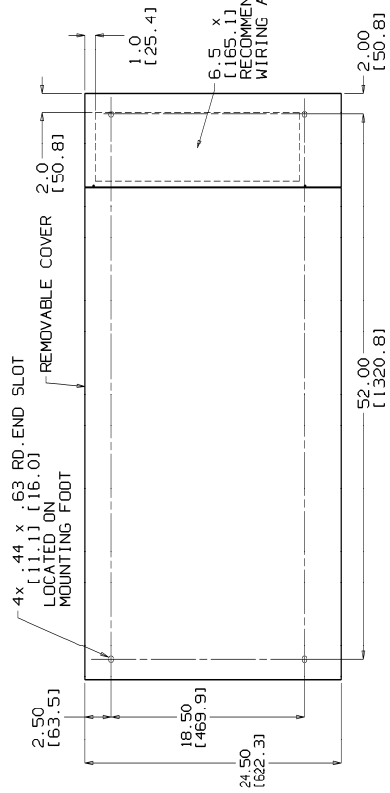

Enclosures DD through GG continues

Note: All dimensions are inches [millimeters]

LTR	ENCLOSURE	
	DD	EE
"F"	27.0 [685.8]	37.0 [939.8]
"G"	31.0 [787.4]	41.0 [1041.4]
"H"	34.0 [863.6]	44.0 [1117.6]
"J"	36.2 [919.4]	46.2 [1173.4]

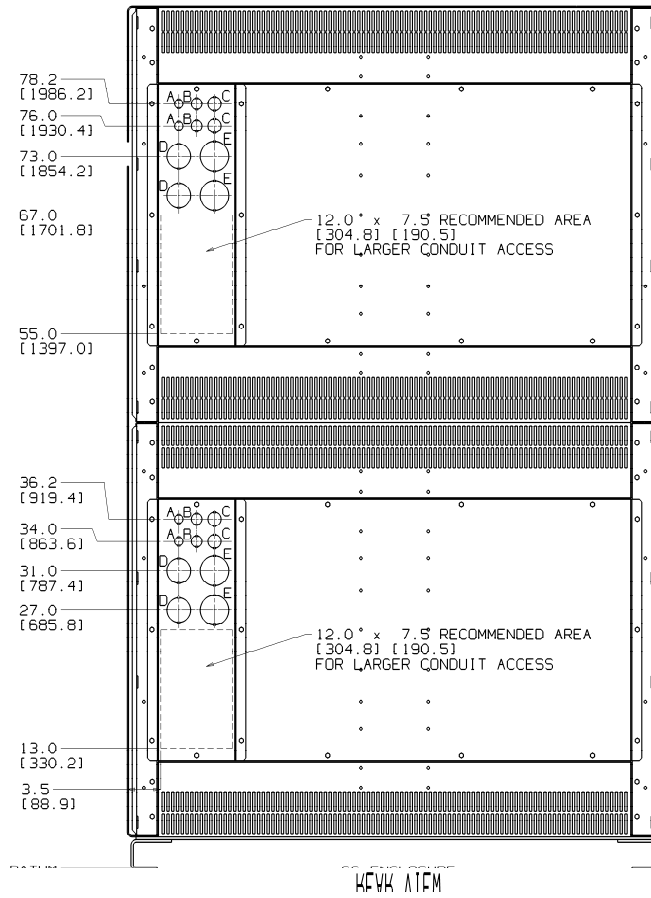
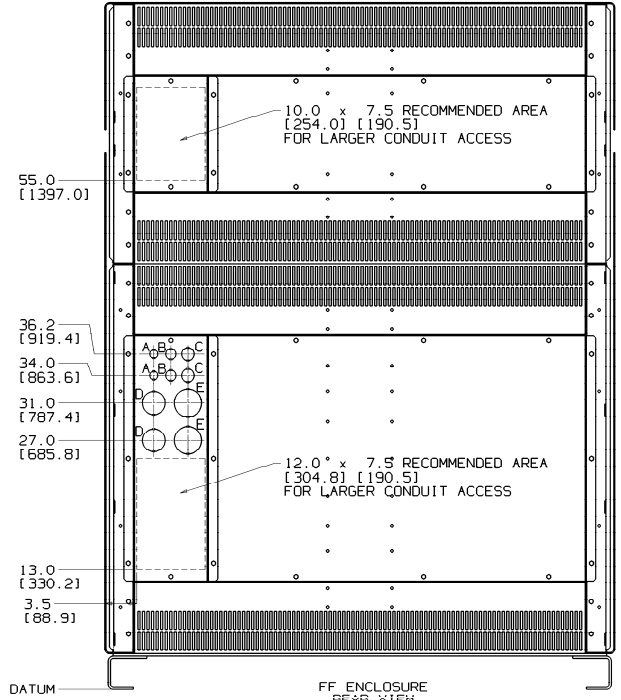
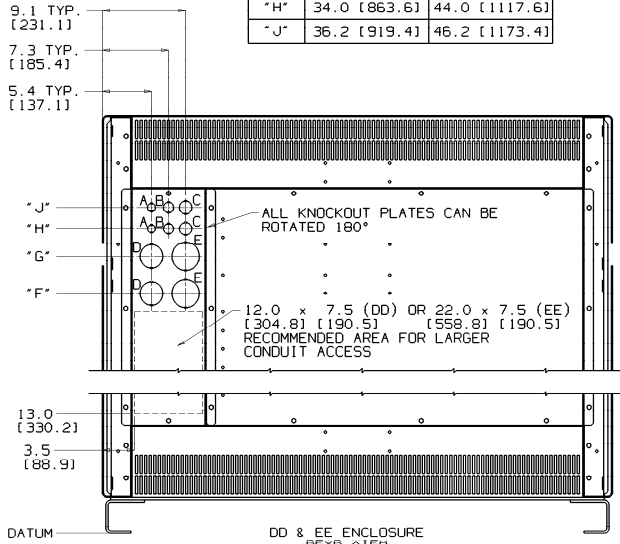

Enclosures EEE through GGG

Note: All dimensions are inches [millimeters]

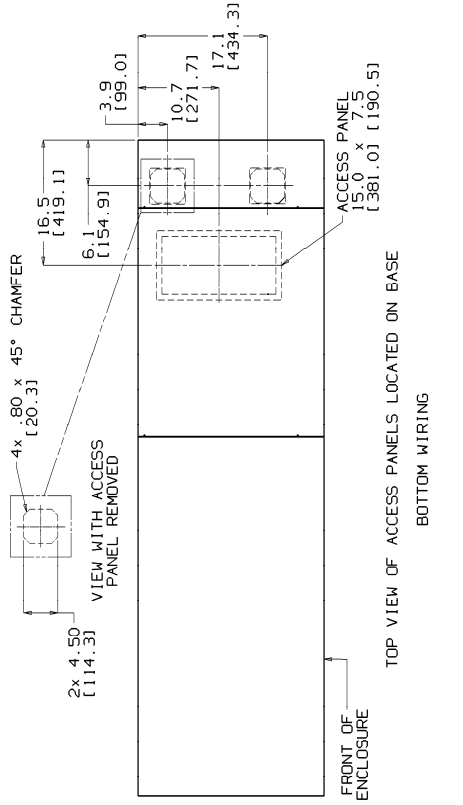

KNOCKOUT LEGEND		
LTR	SIZE OF KNOCKOUT	CONDUIT SIZE
A	Ø .88 [22.3]	.50 [12.7]
B	Ø 1.13 [28.7]	.75 [19.0]
C	Ø 1.38 [35.0]	1.00 [25.4]
D	Ø 2.50 [63.5]	2.00 [50.8]
E	Ø 3.00 [76.2]	2.50 [63.5]

ENCLOSURE DESIGNATION	*H*
EEE	56.25 [1428.7]
FFF	74.25 [1885.9]
GGG	88.25 [2241.5]

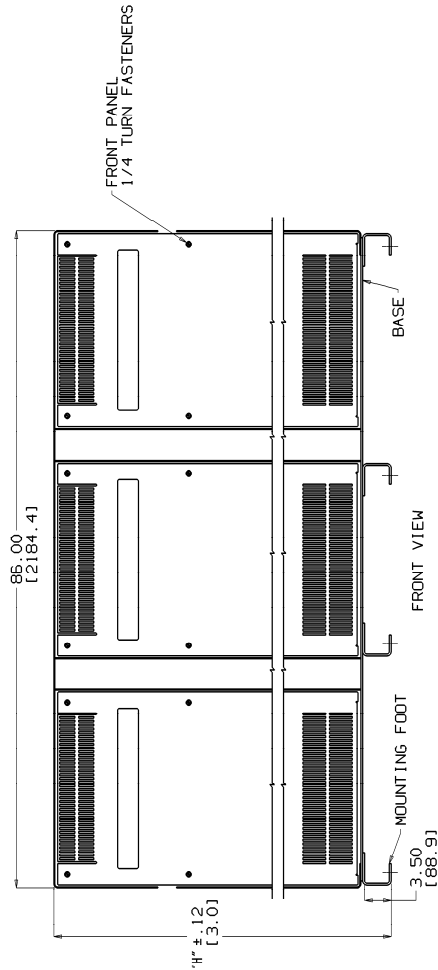
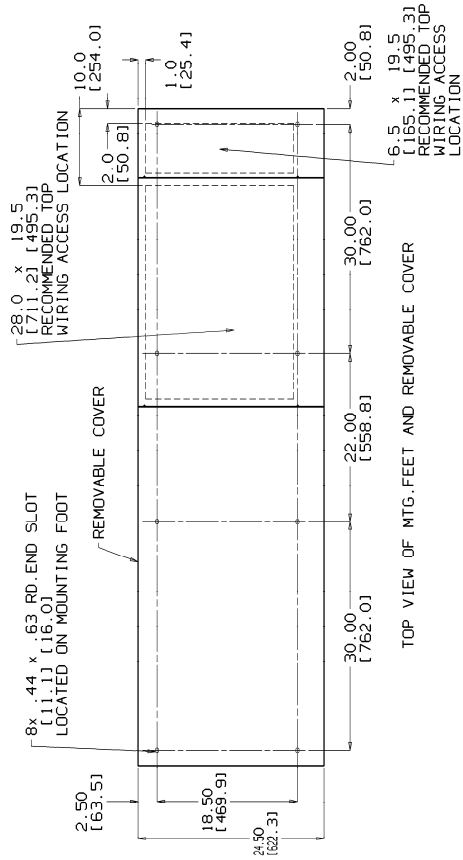

Enclosures EEE through GGG continues

Note: All dimensions are inches [millimeters]

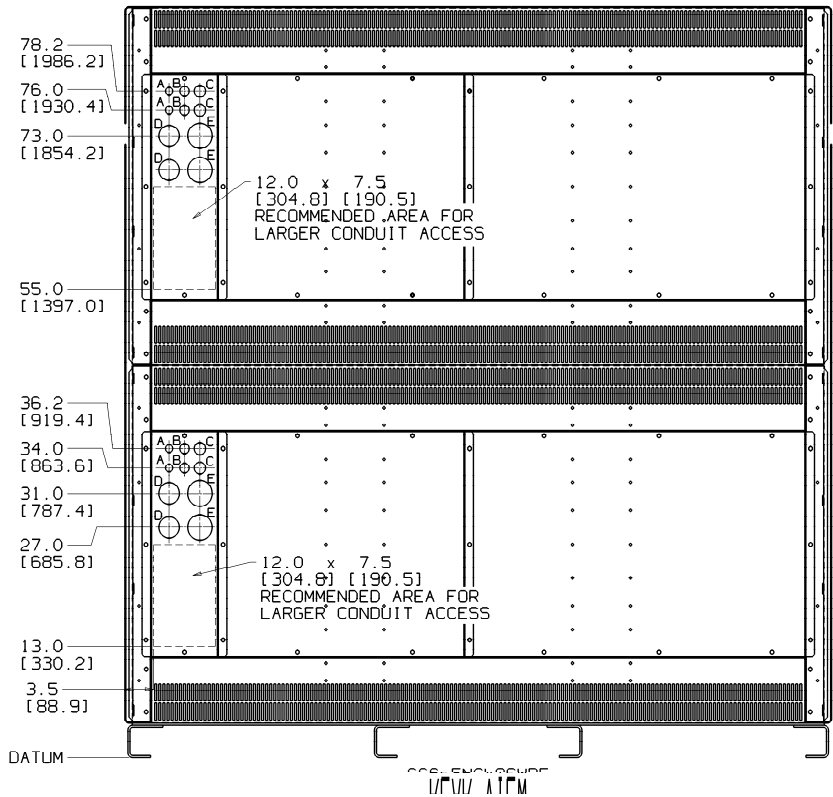
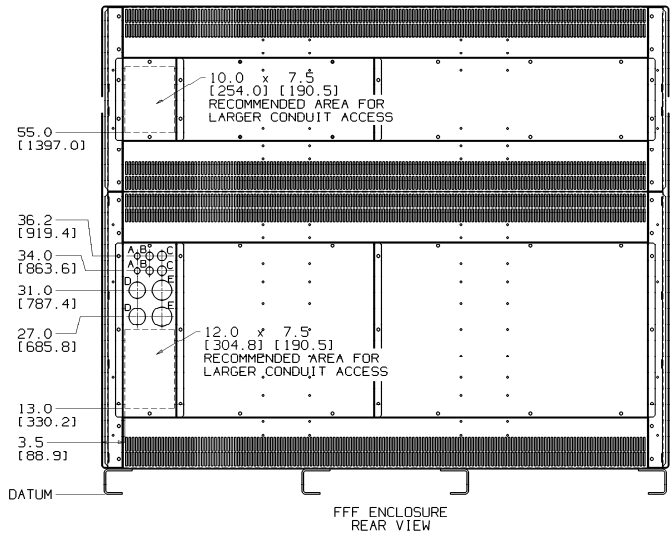
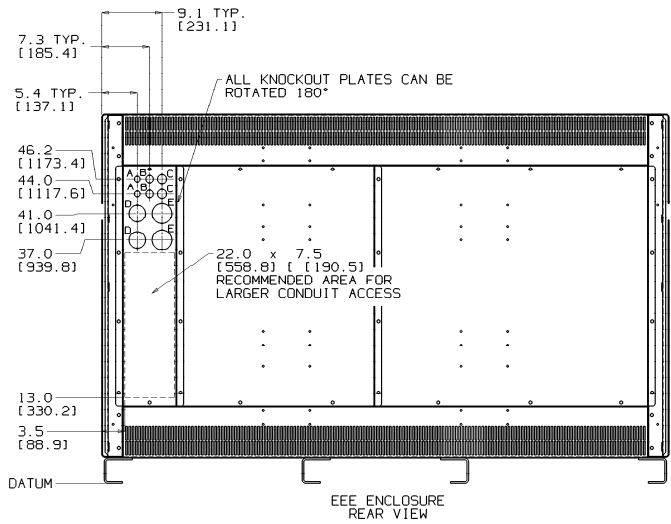

Available Coast-To-Coast and Internationally

Voltage Control Components

VOLT-PAC [®]	Variable Transformers
POWERSTAT [®]	Variable Transformers
LUXTROL [®]	Lighting Controls
5-WAY [®]	Binding Posts
SUPERCON [®]	Electrical Connectors

Voltage Control Components are available worldwide through an extensive Authorized Stocking Distributor network. These Distributors offer literature, technical assistance and a wide range of models off-the-shelf for fastest possible delivery and service.

Power Quality Solutions

STABILINE [®]	Automatic Voltage Regulators
STABILINE [®]	Transient Voltage Surge Suppressors
STABILINE [®]	Uninterruptible Power Supplies
STABILINE [®]	Power Conditioners

STABILINE Power Quality Solutions are available worldwide through an extensive Authorized Distributor and Reseller network, which offer literature, technical assistance and a select range of models off-the-shelf for fastest possible delivery and service.

In addition, Superior Electric Manufacturer's Representatives are available to provide prompt attention to customer needs. Call or fax for ordering and application information or for the address of the closest Manufacturer's Representative, Authorized Distributor or Reseller.



Telephone and Fax Numbers

Telephone 860-507-2025
Fax: 860-507-2050

Customer Service: 860-507-2025 Ext. 70782
Product Application 860-507-2025 Ext. 72058

Toll-Free (in U.S.A. and Canada only)

Telephone 1-800-787-3532
Fax: 1-800-821-1369

Customer Service: 1-800-787-3532 Ext. 70782
Product Application: 1-800-787-3532 Ext. 72058

One Cowles Road • Plainville, CT 06062
www.superiorelectric.com

The right to make engineering refinements on all products is reserved. Dimensions and other details are subject to change.
2013-05-22

213709-104C manual WHR34_S.doc