

Introduction

A new standard of performance and functionality in a compact preset counter. The Squire Preset Item Counter offers a single level of control for item and parts counting and similar production control applications.

The "Supertwist" backlit LCD display provides simultaneous count and preset indication. The use of annunciators and simple key sequences makes operator changes quick and easy. A variety of count sources are accommodated, including relay and pushbutton contacts, photocells and proximity switches. The solid state output can interface to light duty devices and PLCs, while the relay contacts offer heavy duty load switching. Setup and installation is simplified through configuration switches, pluggable terminal strip connectors and a unique "no tools required" panel mount clamp.

The Squire family of preset counters combines state of the art circuitry and electronic assembly techniques with an ergonomic package design that results in the most cost effective, high performance counter value on the market.



Features

- Two line display indicates Count and Preset values simultaneously
- "Supertwist" backlit LCD provides high contrast and visibility in high or low ambient light environments
- Pluggable terminal strip connectors for easy installation and service
- Compact — uses only 48 mm of panel space
- Built-in medium duty relay
- Accessory sensor power supply
- Reset-to-zero or set-to-a-number operation
- Two level program and preset data security
- Accepts current sinking or sourcing sensors
- Key reset, remote reset and auto reset
- Individual, Anti-coincident Add / subtract count inputs
- NEMA 4 / IP65 panel seal with gasket
- Nonvolatile RAM provides 10+ years data and program retention

Index

Overview	
Construction	page 2
Specifications	page 3
Setup	
Configuration Switches	page 4
Front Panel Operation	page 5
Programming	
Viewing Preset Data	page 6
Changing Preset Data	page 6
Program Data	page 7
Installation	
Mounting	page 8
Wiring	page 8,9
Operation	
Diagnostics	page 10
Error Codes	page 11
General	
Ordering Information	page 12
Warranty	page 12
Service	page 12

Technical Manual
701764-1

Veeder-Root brand
Squire
Preset
Item
Counter

CONSTRUCTION

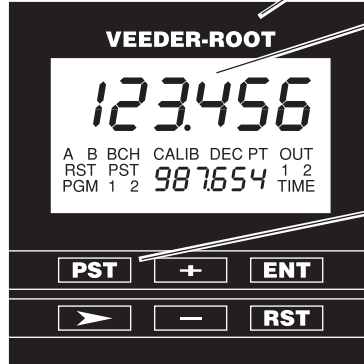

Compact Design

Uses only 48 mm of panel space

Full Featured Display

Simultaneous Count and Preset Data display
Backlit LCD for low ambient light environments
Annunciators show input, display and output status

Ergonomic Keypad

Simple key sequences to view and edit Presets
Front Panel Reset can be disabled

Front Panel Seal

NEMA 4 / IP65 rated when installed with panel mount gasket (supplied)

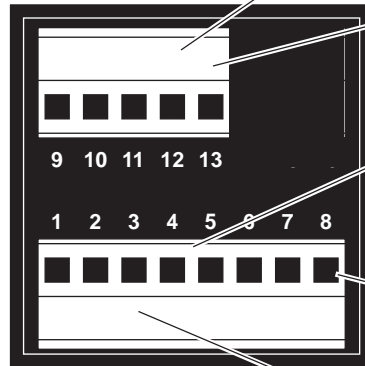

Built-in Relay

Form C (SPDT) contacts
Rated for 120 VAC, 5A or 1/8 hp

Pluggable Terminal Strip Connectors

Allows easy installation and service
Accepts 28 through 14 AWG, stranded wires

Count Inputs

Separate A and B channels for Add / Subtract counting
Compatible with sinking or sourcing sensors

Control Inputs

Remote Reset of Count
Program Input allows access to setup data

DC Input / Output

Provides output to power sensors or encoder
Accepts 10 to 26 VDC external input power

SPECIFICATIONS

IMPORTANT:

Do not connect AC power when using an external dc source to power the unit.

CAUTION:

Avoid cleaning agents which contain ammonia! Repeated contact with ammonia may weaken the plastic. Many lubricants are not compatible with the structural plastic of the counter housing. Repeated exposure to these lubricants may weaken the plastic.

Input Power

AC: Terminals 9 (HOT/L1) and 10 (NEU/L2)
95 to 130 VAC (190 to 260 VAC for SQC11E00), 50/60 Hz, 6 VA
DC: Terminals 3 (+VDC) and 6 (COM)
10 to 26 VDC, 0.4 A. max. total

Output Power

DC: Terminal 3 (+VDC) and 6 (COM)
9 to 15 VDC, 0 to 100 mA. max.
12 VDC nominal at 115 (230) VAC

Main Counter

Decades: 6, bidirectional, (rollover from 999 999 to 0 and rollunder from 0 to 999 999)
Preset: 1, 6 decades each
Operation: Add / Subtract (Signal A counts up; Signal B counts down);
Direction: Up (reset-to-zero); or Down (set-to-a-number) when switch #3 is down
Count Rate: DC to 20 Hz max.
Resets: Remote manual; Front Panel disabled when switch #1 is down; Auto Reset when switch #2 is down

Calibrator

Fixed: 1 Input pulse = 1 Count digit

Count Inputs

Signal A: Terminal 4 (SIG A)
Signal B: Terminal 5 (SIG B)
Input Voltage, High: 3 min. to 26 VDC max.
Input Voltage, Low: 0 min. to 2.0 VDC max.
Input Impedance: 10 k Ω to COM; optional 4.7 k Ω to +VDC when switch #5 is down
Input Response: 25 msec. min. pulse

Control Inputs

Remote Reset: Terminal 7 (RST)
Program Mode: Terminal 8 (PGM)
Input Voltage, High: 3 min. to 26 max.
Input Voltage, Low: 0 min. to 2.0 VDC max.
Input Impedance: 4.7 k Ω to +VDC
Input Response: 25 msec. min. pulse

Front Panel Keys

Type: Conductive rubber, tactile response

Display

Type: "Supertwist" Transflective LCD; LED backlighting
Main Counter: 6 digits, 0.25" (7 mm) height
Preset: 6 digits, 0.13" (4 mm) height
Decimal Point: XXX XXX (none) to XX.XXXX

Security

Preset Data: Protected when switch #4 is down; accessible only in Program Mode
Program Data: Accessible only in Program Mode;

Solid State Output

Output 1: Terminal 1 (OUT 1)
Type: NPN open collector, sink to COM
Output High: 30 VDC max., 100 μ A. max. leakage current
Output Low: 1 VDC max., 100 mA. max.
Operation: Latched; or Momentary from 0.01 to 99.99 sec. +0, -10 msec.
Assignment: Output 1 turns on at Preset 1, turns off at manual Reset (Output 1 turns on at Counter=0, turns off at Reset if switch #3 is down)

Relay Output

Relay 1: Terminals 11 (NC), 12 (NO), 13 (C)
Type: Form C (SPDT)
Ratings: 5 A. res. at 24 VDC or 120 VAC; 3 A. res. at 240 VAC; 1/8 hp at 120/240 VAC
Assignment: Relay 1 turns on at Preset 1, turns off at manual Reset (Relay 1 turns on at Counter=0, turns off at Reset if switch #3 is down)

Mechanical

Enclosure Dimensions: 1.7" (44 mm) square X 5.1" (130 mm) long
Bezel Dimensions: 1.9" (48 mm) square X 0.2" (4 mm) deep
Panel Cutout Size: 1.8" (45 mm) square
Panel Thickness: 1/16" (2 mm) to 1/2" (13 mm)
Depth Behind Panel: 5.6" (144 mm)

Environmental

Operating Temp.: 32 to 122 °F. (0 to 50 °C.)
Storage Temp.: 0 to 186 °F. (-18 to 85 °C.)
Ambient Humidity: 0 to 90% noncondensing
Front Panel Seal: NEMA 4 / IP65 when installed with panel gasket (supplied)

SETUP

CONFIGURATION SWITCHES

Record your Configuration Switch settings in the chart at right for future reference.

--	--	--	--	--	--

1 2 3 4 5

	UP	DOWN
1	Key Reset Disabled Front Panel RST key will not reset the Counter.	Key Reset Enabled Front Panel RST key will cause a Counter reset when pressed.
2	No Automatic Reset Counter must be manually reset from remote reset input or front panel key.	Automatic Reset Counter repeats count cycle (Reset-to-Zero or Set-to-a-Number) at detection of Preset 1.
3	Reset-to-Zero Operation Reset (manual or automatic) causes Counter to go to zero.	Set-to-a-Number Operation Reset (manual or automatic) causes Counter to load to value of Preset 1. Output is triggered at Counter value of 0.
4	Preset Data Unlocked Presets can be changed by front panel keys without activating PGM input.	Preset Data Locked Presets can be viewed by use of front panel keys. Presets can be changed only when PGM input is active.
5	No Input Pullup Resistors Use with current sourcing, PNP or totem-pole output devices and contact closures to +VDC.	Input Pullup Resistors Use with current sinking, NPN or totem-pole output devices and contact closures to COM.

NOTE:
 Switch positions 6 – 8 are not used and have no functions.

FRONT PANEL OPERATION

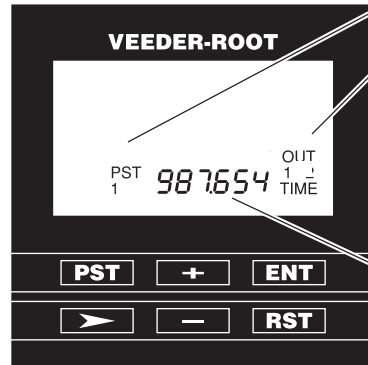

Prompts

Annunciators are used to indicate which Preset and Programming Data is being displayed:

PST 1 Preset 1 Data

Also, when the PGM input is active:

OUT 1 TIME Output 1 Momentary Time

Data Display

Contains Preset and Programming Data for operator viewing and changes. Also displays Program Data and Decimal Point setting when PGM input is active.

NOTE:

To abort changes to a Preset or Program Data value, press the Preset / Select key instead of the Enter key.

PST Preset / Select

This key will select data to be displayed. When the PGM input is active, this key selects various program data for display: Preset 1 and Output 1 Time.

IMPORTANT:

You must press the Enter key to transfer new data into memory within 10 seconds of your last keypress.

ENT Enter

The Enter key transfers edited Preset or Program Data to nonvolatile memory. The new value is not used until the Enter key is pressed.

During normal operation a ten second timer is in effect. If a Preset has been changed but not entered, the Preset Data will revert back to its old value after 10 seconds of inactivity.

RST Reset

The Counter may be reset from the front panel if switch #1 is down. The Counter is reset only once for each keypress, even if held.

NOTE:

Selected (flashing) digits are shown in this manual in outline form:

123.456

> Next Digit

This key selects one digit of data to be changed. The first keypress will select the leftmost digit; additional presses will select digits further to the right. The chosen digit will flash twice per second. That digit may then be changed with the + and - keys.

+ Increment / Decrement **-**

The + key will change the selected (flashing) digit of Preset or Program Data by adding 1 to it. Rollover occurs from 9 back to 0. The - key similarly subtracts 1, and will rollunder from 0 to 9. Holding either key in will cause the digit to change repeatedly about twice per second.

When setting the Decimal Point position, use the + key to increase the number of digits appearing to the right of the decimal point; use the - key to decrease that number.

VIEWING PRESET DATA

Data Displays:



Preset 1

CHANGING PRESET DATA

NOTE:

To abort changes to a Preset or Program Data value, press the Preset / Select key instead of the Enter key.

WARNING!

Caution should be observed if it is necessary to change preset values while the process is operating. Do not set to values which are already exceeded by the count value without resetting the counter.

IMPORTANT:

You must press the Enter key to transfer new data into memory within 10 seconds of your last keypress.



Preset Data cannot be changed if Preset Data Lock, switch #4, is down.

Use the Next Digit key to select one digit to change. The selected digit begins to flash.

Change the selected digit with the + and - keys.

When the all of the digits have been correctly set, press the Enter key to transfer the new value into memory.

PROGRAM DATA

NOTE:

To access Program Data, PGM input (terminal 8) must be active (low or tied to COM).

IMPORTANT:

You must press the Enter key to transfer new data into memory.

WARNING!

Changing program data values while the process is operating may be hazardous to the operator and/or the controlled equipment. Use extreme caution and stop the process before attempting to change program data values.

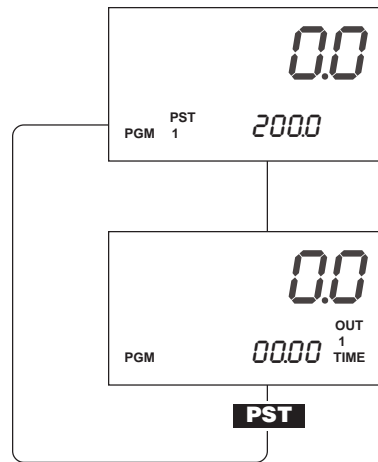

Preset 1

Preset 1 appears in Program Data only if Preset Data Lock, switch #4, is down.

Output 1 Time

Sets the momentary on time for Output 1 (Preset 1) from 0.01 to 99.99 seconds. Set to 00.00 for latched operation.

INSTALLATION

PANEL MOUNTING

NOTE:

For multiple unit installations, the counters can be installed with close unit-to-unit spacing in horizontal rows or vertical columns, but not both. Observe the minimum unit-to-unit clearance shown.

For side by side mounting, the rounded handles of the panel mount clamp will be located at the top and bottom of the counter. For vertical mounting, the clamp can be rotated so that its handles are on the left and right sides of the counter.

Panel Mounting

Make cutout(s) according to the details in the drawing at right.

If the installation requires a front panel seal, slide the panel sealing gasket over the rear of the counter up to the bezel.

Slide the counter through the panel cutout.

DO NOT squeeze the (rounded) handles of the panel mount clamp during installation. This may cause the clamp to slide back before locking into place and result in a loose panel mounting.

Slide the panel mount clamp, with the springs pointed toward the panel, over the rear of the unit. Push the clamp as far forward as possible. The clamp will lock into the corners of the enclosure.

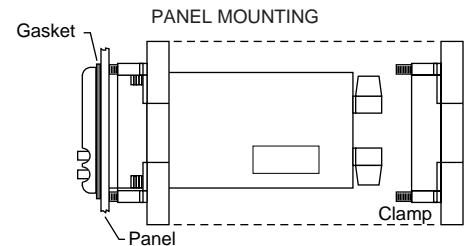
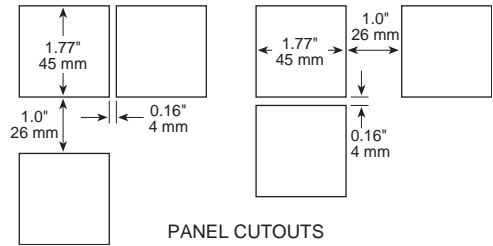
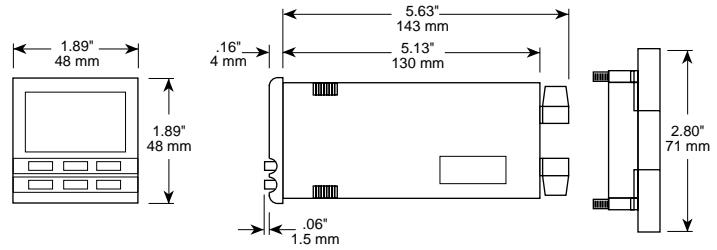

IMPORTANT: In severe electrical noise environments, shielded cable for signal inputs and outputs is recommended. Connect the shield only to building (Earth) ground.

WIRING

IMPORTANT:

Do not connect AC power when using an external DC supply to power the unit.

WARNING!

In installation and use of this product, comply with the national electrical code; federal, state and local codes, and any other applicable safety codes. In addition, turn off power and take other necessary precautions during installation, service and repair to prevent personal injury, property loss and equipment damage.

AC Power Input

Connect AC power to L1/HOT (terminal 9) through a 1/8 A., "slow blow" type fuse and to L2/NEU (terminal 10), as shown in the diagram on the right. AC power should be from a separate branch circuit that is noise-free and does not feed heavy loads.

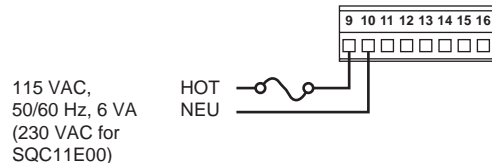

DC Power Input

Connect DC supply to +VDC (terminal 3) through a 1/2 A., "slow blow" type fuse and return to COM (terminal 6), as shown in the diagram on the right. DC power should have low ripple and be noise-free.

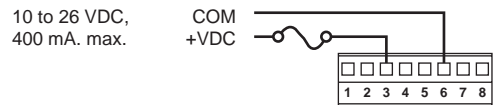

Relay Outputs

Connect AC or DC load circuits to relays contacts on terminals 11 through 13 as needed. DO NOT route load wiring near count input or transistor output signals. Load switching noise can be minimized with RC or MOV suppression.

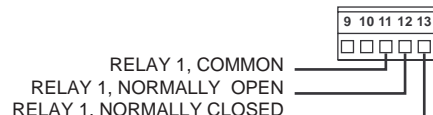

NOTE:
When using current sourcing devices, set switch #5 to up.



NOTE:
When using current sinking devices, set switch #5 to down.

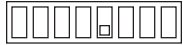

Current Sourcing Count Inputs

Set switch #5 to up.

For Add/Subtract operation, set switch #7 to up. Connect Add count input to Signal A (terminal 4) and/or Subtract count input to Signal B (terminal 5) and +VDC (terminal 3) as shown on the right.

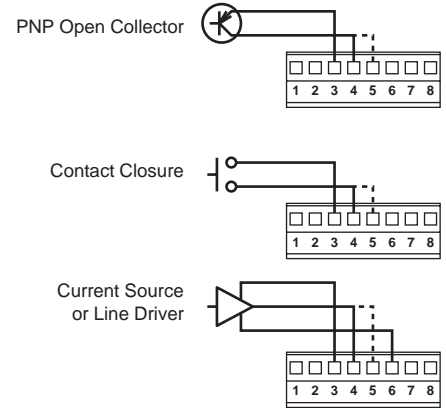

Current Sinking Count Inputs

Set switch #5 to down.

For Add/Subtract operation, set switch #7 to up. Connect Add count input to Signal A (terminal 4) and/or Subtract count input to Signal B (terminal 5) and COM (terminal 6) as shown on the right.

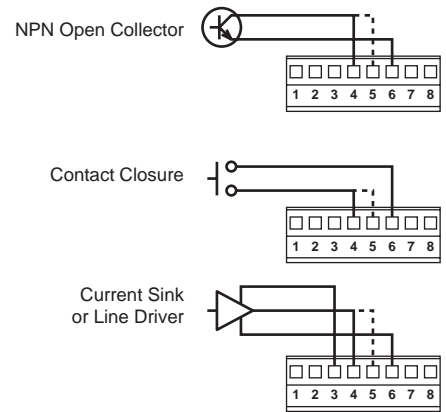

WARNING!
When the counter is used to control a machine or process where personal injury or equipment damage might occur as a result of failure of any electronic or other counter function, you are urgently recommended to insist on installation of safeguards which would protect the operator and/or machine in the event of any unexpected operation of the machine or process.

Reset and Program Inputs

Connect Reset pushbutton or current sink device to RST (terminal 7), Program switch or jumper to PGM (terminal 8) and COM (terminal 6).

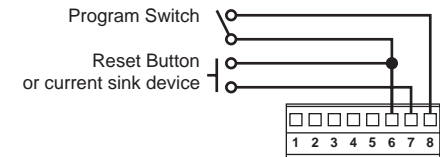

Solid State Output

Connect Output 1 (terminal 1) and COM (terminal 6) to solid state devices as shown at right, top.

To drive DC relay coils, connect Output 1 and +VDC (terminal 3) as shown at right, bottom. Suppress turn-off transients with a flyback diode, connected as shown.

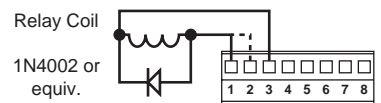
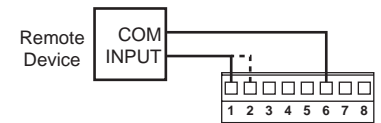

DIAGNOSTICS

NOTE:
The Diagnostic can be displayed only upon application of power when the ENT key is being pressed.

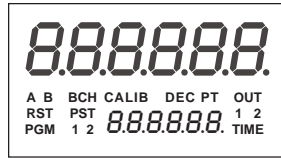

NOTE:
To exit from the Diagnostic display, press the ENT key. Normal display operation will resume.

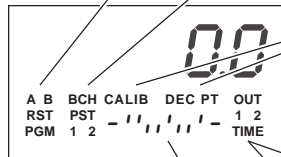

To start the Diagnostic display: turn power off, press and hold the Enter key, and re-apply power.

Display

The first diagnostic will turn on all digit segments and annunciators, as shown on the left. Segments that do not appear may indicate a malfunction. Press any key to end the Display Test.

Inputs

The electrical states of the count and control inputs are shown by the four legends. The displays are On for active (low) inputs.

Preset / Select Key

The PST key can be tested by observing the display. Consecutive keypresses will cycle the annunciators (BCH-PST-1-2-BCH-etc.).

Reset Key

The RST key is tested (but is otherwise inactive) by its alternating the CALIB and DEC PT prompts.

Next Digit Key

This key alternately displays OUT 1 and OUT 2.

Outputs (and + and - Keys)

When OUT 1 or OUT 2 is displayed (above), the outputs can be turned on and off. The + key will turn on (or trigger for the momentary time) the output; the - key will turn the output off.

Switches

The Configuration Switch settings can be checked and tested by viewing the Data Display. Each switch will display either an upper segment, if the switch is up, or the lower segment, if the switch is down.

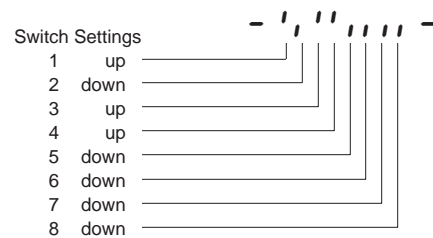

ERROR CODES

NOTE:

Error code displays can be cleared by pressing any front panel key.

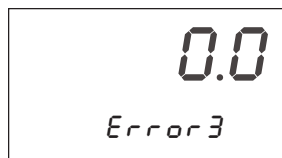

IMPORTANT:

Error displays indicate abnormal operating conditions! Count, Preset or Program Data may not be valid and should be checked before continuing.



The Squire Counter has the ability to detect and display certain external conditions which prevent normal counter operation. These are shown in the lower Data display as numeric codes which are described below.

Brownout

This error is caused by the AC or DC input power falling below the minimum operating voltage. This error will not be displayed during normal power off-on cycles unless the input power rises slowly. The Count data is stored in nonvolatile memory before power is lost.

Input Too Fast

This error is the result of an excessive count rate usually caused by count signal inputs above the maximum operating frequency. This error may also result from noise at the count signal inputs.

Nonvolatile Memory Failure

This error appears upon application of power. This failure may mean that Count, Preset, or Program data has been corrupted and should be checked.

GENERAL

ORDERING INFORMATION

Model	Description
SQC11000 115VAC	Squire Preset Item Counter,

Model	Description
SQC11E00 230VAC	Squire Preset Item Counter,

WARRANTY

Standard products manufactured by the Company are warranted to be free from defects in workmanship and material for a period of one year from the date of shipment, and products which are defective in workmanship or material will be repaired or replaced, at the option of the Company, at no charge to the Buyer. Final determination as to whether a product is actually defective rests with the Company. The obligation of the Company hereunder shall be limited solely to repair and replacement of products that fall within the foregoing limitations, and shall be conditioned upon receipt by the Company of written notice of any alleged defects or deficiency promptly after discovery within the warranty period, and in the case of components or units purchased by the Company, the obligation of the Company shall not exceed the settlement that the Company is able to obtain from the supplier thereof. No products shall be returned to the Company

without its prior consent. Products which the Company consents to have returned shall be shipped F.O.B. the Company's factory. The Company cannot assume responsibility or accept invoices for unauthorized repairs to its components, even though defective. The life of the products of the Company depends, to a large extent, upon the type of usage thereof, and THE COMPANY MAKES NO WARRANTY AS TO FITNESS OF ITS PRODUCTS FOR SPECIFIC APPLICATIONS BY THE BUYER NOR AS TO PERIOD OF SERVICE UNLESS THE COMPANY SPECIFICALLY AGREES OTHERWISE IN WRITING AFTER THE PROPOSED USAGE HAS BEEN MADE KNOWN TO IT.

THE FOREGOING WARRANTY IS EXCLUSIVE AND IN LIEU OF ALL OTHER WARRANTIES EXPRESSED OR IMPLIED, INCLUDING, BUT NOT LIMITED TO ANY WARRANTY OF MERCHANTABILITY OR OF FITNESS FOR A PARTICULAR PURPOSE.

SERVICE

If this product requires service, call the number below for an Return Material Authorization (RMA) number, pack it in a sturdy carton with the RMA number clearly marked on the outside, and ship prepaid to: Service Department at the address below.

Please Include:

1. A description of problem
2. The name of responsible person
3. Your purchase order number
4. Your return shipping instructions