

IOM

MPR180416 Rev. B



F78MP Series Air Radar Installation & Operation Manual



F78MP Series Air Radar Installation & Operation Manual

CONTENTS

I.	HANDLING AND STORAGE	1
	Inspection and Handling	
	Disposal and Recycling	
	Storage	
II.	GENERAL SAFETY.....	2
	Authorized Personnel	
	Use	
	Misuse	
III.	PRODUCT DESCRIPTION	4
	Function	
	Technical Specifications	
IV.	MECHANICAL INSTALLATION	6
	Guidelines	
	Mounting Considerations	
V.	ELECTRICAL INSTALLATION.....	10
	General Safety	
	Disconnect Requirements For Permanently Installed Equipment	
	Wiring	
VI.	SET UP	13
VII.	MAINTENANCE	33
VIII.	TROUBLESHOOTING	34

SAFETY SYMBOLS



WARNING:

IDENTIFIES CONDITIONS OR PROCEDURES, WHICH IF NOT FOLLOWED, COULD RESULT IN SERIOUS INJURY. RISK OF ELECTRICAL SHOCK.



CAUTION:

IDENTIFIES CONDITIONS OR PROCEDURES, WHICH IF NOT FOLLOWED, COULD RESULT IN SERIOUS DAMAGE OR FAILURE OF THE EQUIPMENT.

MP Series Air Radar Installation & Operation Manual

I. HANDLING AND STORAGE

SAVE THESE INSTRUCTIONS

INSPECTION AND HANDLING

Do not dispose of the carton or packing materials.

Each package should be inspected upon receipt for damage that may have occurred due to mishandling during shipping. If the unit is received damaged, notify the carrier or the factory for instructions. Failure to do so may void your warranty. If you have any problems or questions, consult Customer Support at 800-778-9242.

DISPOSAL AND RECYCLING

This product can be recycled by specialized companies and must not be disposed of in a municipal collection site. If you do not have the means to dispose of properly, please contact for return and disposal instructions or options.

STORAGE

If the device is not scheduled for immediate installation following delivery, the following steps should be observed:

1. Following inspection, repackage the unit into its original packaging.
2. Select a clean dry site, free of vibration, shock and impact hazards.
3. If storage will be extended longer than 30 days, the unit must be stored at temperatures between 32° and 158° F (0° to 70° C) in non-condensing atmosphere with humidity less than 85%.



CAUTION: DO NOT STORE A NON-POWERED UNIT OUTDOORS FOR A PROLONGED PERIOD.

II. GENERAL SAFETY

AUTHORIZED PERSONNEL

All instructions described in the document must be performed by authorized and qualified service personnel only. Before installing the unit, please read these instructions and familiarize yourself with the requirements and functions of the device. The required personal protective equipment must always be worn when servicing this device.

USE

The device is solely intended for use as described in this manual. Reliable operation is ensured only if the instrument is used according to the specifications described in this document. For safety and warranty reasons, use of accessory equipment not recommended by the manufacturer or modification of this device is explicitly forbidden. All servicing of this equipment must be performed by qualified service personnel only. This device should be mounted in locations where it will not be subject to tampering by unauthorized personnel.

MISUSE

Improper use or installation of this device may cause the following:

- Personal injury or harm
- Application specific hazards such as vessel overfill
- Damage to the device or system

If any questions or problems arise during installation of this equipment, please contact Customer Support at 800-778-9242.

INDUSTRY CANADA

The MP Series radar complies with Industry Canada standard RSS211 (March 2015).

- a. The installation of the MP Series radar shall be done by trained installers, in strict compliance with the manufacturer's instructions.
- b. The use of this device is on a "no-interference, no-protection" basis. That is, the user shall accept operations of high-powered radar in the same frequency band which may interfere with or damage this device. However, devices found to interfere with primary licensing operations will be required to be removed at the user's expense.
- c. The installer/user of this device shall ensure that it is at least 10 km from the Dominion Astrophysical Radio Observatory (DRAO) near Penticton, British Columbia. The coordinates of the DRAO are latitude 49°19'15" N and longitude 119°37'12" W. For devices not meeting this 10 km separation (e.g., those in the Okanagan Valley, British Columbia,) the installer/user must coordinate with, and obtain the written concurrence of, the Director of the DRAO before the equipment can be installed or operated. The Director of the DRAO may be contacted at 250-497-2300 (tel.) or 250-497-2355 (fax). (Alternatively, the Manager, Regulatory Standards, Industry Canada, may be contacted.)

FCC CONFORMITY

US Installations only: Federal Communications Commission (FCC) rules



WARNING: CHANGES OR MODIFICATIONS NOT EXPRESSLY APPROVED BY BINDICATOR COULD VOID THE USER'S AUTHORITY TO OPERATE THE EQUIPMENT.

- This device has been tested and found to comply with the limits Class B digital device part 15 of the FCC Rules. These limits are designed to provide reasonable protection against harmful interference when the equipment is operated in a commercial environment.
- This device has also been tested and found to comply with the limits §15.256, Subpart C-Intentional radiators, pursuant to Part 15 of the FCC Rules. These limits are designed to provide reasonable protection against harmful interference when the equipment is operated in a commercial environment.
- This device generates, uses, and can radiate radio frequency energy and, if not installed and used in accordance with the instruction manual, may cause harmful interference to radio communications, in which case the user will be required to correct the interference at his/her own expense.
- This device is certified to measure levels in fixed or mobile enclosed tanks.
- This device may be used to measure levels in open air environments or outside enclosed tanks, subject to the following conditions:
 - Devices shall be installed and maintained to ensure a vertically downward orientation of the transmit antenna's main beam.
 - Devices shall be installed only at fixed locations. Devices shall not operate while being moved or while inside a moving container.
 - Hand-held applications and residential use are prohibited.

R&TTE COMPLIANCE (EUROPE)

Hereby, Bindicator, declares that the MP Series Air Radar is in compliance with the essential requirements and other relevant provisions of Directive 1999/5/EC.

The MP Series Air Radar complies with EN 302 372 for use in closed storage vessels, when installed according to the installation requirements of EN 302 372, and may be used in all EU countries.

The MP Series Air Radar complies with EN 302 729 for use outside of closed tanks in EU countries. For open air installations, the following conditions must be observed:

Installation and maintenance is performed by suitably qualified and trained personnel.

The MP Series Radar shall be installed only in a permanent fixed position pointing downwards. Its location shall comply with the following two restrictions:

1. It shall be installed with a minimum separation distance of 2.5 miles (4 km) from Radio Astronomy sites listed at www.craf.eu/raobs.htm unless special authorization has been provided by the responsible national regulatory authority.
2. If it is installed at a location between 2.5 and 25 miles (4 and 40 km) from any Radio Astronomy site listed at www.craf.eu/raobs.htm, the MP Series Air Radar shall be installed at a height not exceeding 50 ft (15m) from the ground.

III. PRODUCT INFORMATION

Bindicator MP Series air radar is a 2-wire, 78 GHz FMCW radar level transmitter for continuous monitoring of solids in vessels; available in a range of 131 ft (40 m) or 329 ft (100 m), model F78MP040 or F78MP100, respectively. The plug and play performance is ideal for all solids applications, including those with extreme dust and high temperatures to +392 °F (+200 °C). The device is an electronic circuit coupled to a lens antenna and flange for quick and easy positioning.

The main benefits of using 78 GHz over devices using lower frequency are:

- very narrow beam, so device is insensitive to mounting nozzle interference and vessel obstructions.
- short wavelength yields very good reflection properties on sloped solids, so aiming towards material angle of repose is usually not necessary.

The technology is very tolerant to buildup on the lens antenna, however an air purge inlet is provided for periodic cleaning if required. The MP Series air radar supports HART communication protocol. Signals are processed using detailed algorithms which have been field-proven in over 1,000,000 applications worldwide.

APPLICATIONS include cement powder, plastic powder/pellets, grain, flour, coal and other applications

Local Display Interface (LDI)

- Allows you to copy parameters from one device to another
- Displays level and diagnostic information including echo profile and trend over time
- Can be mounted in 1 of 4 positions at 90 degree intervals, for easy viewing after installation
- Backlit for easy viewing in dimly lit areas
- Provides high speed firmware transfer capabilities for future upgrades



FUNCTIONAL

Power Supply	Nominal 24 VDC with max 550 Ohm loop resistance; Maximum 30 VDC
Dead Zone	15.7 in. (400 mm) from mounting plate
Measurable Distance	131 ft (40 m) or 328 ft (100 m)
Transmitting frequency	78 to 79 GHz FMCW
Update Time	Maximum 10 seconds (depending on Settings)
Beam angle	4 degrees

PERFORMANCE

Accuracy	0.2 in. (5mm)* including hysteresis and non-repeatability
Ambient Temperature	-40 to 175 °F (-40 to 80 °C)
Ambient Pressure	12 to 15 psi (860 to 1060 mbar)
Process Temperature	-40 to 392 °F (-40 to 200 °C)
Output signal	4 to 20 mA
HART Communication	
Load	230 to 550 Ohm; 230 to 500 Ohm when connecting a coupling module
Maximum Line Length	4921 ft (1500 m) multi-wire
Humidity	45 to 75% relative humidity
Dielectric Constant	Minimum dK of 1.6 for ranges up to 65.6 ft (20 m) Minimum dk of 2.5 for ranges up to 328 ft (100 m)

PHYSICAL

Material	316 Stainless Steel with polyurethane powder coat finish
Protection	Type 4X/NEMA 4X; Type 6/NEMA 6, IP68
Conduit Entry	1/2" NPT
Mass	6.94 lb (3.15 kg) (with 3" SS flange)
Mounting	4, 6 or 8 in. flange or aiming flange

ENVIRONMENTAL

Location	Indoor/outdoor
Altitude	16,404 ft (5000 m) max
Installation Category	I
Pollution Degree	4

*Under severe EMI/EMC environments per IEC61326-1 or NAMUR NE21, the device error may increase to a maximum of 1" (25 mm)

APPROVALS & RATINGS
FM and CSA

Hazardous: Dust Ignition Proof: Class II, Div1, Groups E, F, G; Class III T4

Hazardous: Non-incendive: Class I, Div 2, Groups A, B, C, D, T4

CE

Electromagnetic Compatibility Directive

Low Voltage Directive

IV. MECHANICAL INSTALLATION



WARNING: REMOVE POWER FROM THE UNIT BEFORE INSTALLING, REMOVING, OR MAKING ADJUSTMENTS.



WARNING: INSTALLATION SHALL BE PERFORMED ONLY BY QUALIFIED PERSONNEL AND IN ACCORDANCE WITH LOCAL GOVERNING REGULATIONS.



WARNING: MP SERIES AIR RADAR IS TO BE USED ONLY IN THE MANNER OUTLINED IN THIS MANUAL, OTHERWISE PROTECTION PROVIDED BY THE DEVICE MAY BE IMPAIRED.



WARNING: NEVER ATTEMPT TO LOOSEN, REMOVE, OR DISASSEMBLE PROCESS CONNECTION OR INSTRUMENT HOUSING WHILE VESSEL CONTENTS ARE UNDER PRESSURE.



WARNING: THE USER IS RESPONSIBLE FOR THE SELECTION OF BOLTING AND GASKET MATERIALS WHICH WILL FALL WITHIN THE LIMITS OF THE FLANGE AND ITS INTENDED USE AND WHICH ARE SUITABLE FOR THE SERVICE CONDITIONS.



WARNING: IMPROPER INSTALLATION MAY RESULT IN LOSS OF PROCESS PRESSURE.



WARNING: MP SERIES AIR RADAR LEVEL MEASUREMENT INSTRUMENT FALLS BELOW THE LIMITS OF ARTICLE 3, SECTIONS 1&2 OF THE PRESSURE EQUIPMENT DIRECTIVE (PED, 97/23/EC), AS A CATEGORY I PRESSURE ACCESSORY. HOWEVER, IN ACCORDANCE WITH PED, 97/23/EC, ARTICLE 3, SECTION 3, THIS EQUIPMENT HAS BEEN DESIGNATED AND MANUFACTURED IN ACCORDANCE WITH SOUND ENGINEERING PRACTICE (SEP) (SEE EU COMMISSION GUIDELINE 1/5).

GUIDELINES & CONSIDERATIONS

The following precautions should be observed when installing the MP Series air radar units:

- Correct location is key to a successful application
- Avoid reflective interference from vessel walls and obstructions by following the guidelines below.
- Should not be mounted near the fill stream

BEAM

- Beam angle is the width of the cone where the energy density is half of the peak energy density.
- The peak energy density is directly in front of and in line with the antenna.
- There is a signal transmitted outside the beam angle, therefore false targets may be detected.
- Keep emission cone free of interference from ladders, pipes, I-beams or filling streams.
- Avoid central locations on tall, narrow vessels

ENVIRONMENT

- Provide an environment suitable to the housing rating and materials of construction

Ambient Temperature: -40 to 176 °F (-40 to 80 °C)

Process Temperature: -40 to 392 °F (-40 to 200 °C)

AIMER ADJUSTMENT

- Aiming will assist in measuring material in the cone, but is generally not required for signal optimization.

Once location of the unit has been determined, use flange to mount; if using an aimer flange, see instructions below.

1. For 4" and 6" Aimer: Loosen the set screws in the locking ring. Holding the electronics enclosure firmly, loosen the Aimer locking ring using the supplied C spanner, until the unit drops down slightly. The enclosure can then be turned freely.
2. Direct the MP SERIES air radar so the antenna is pointed at an angle perpendicular to the material surface, if possible.
3. When the desired position is reached, re-tighten the locking ring using the Cspanner, and tighten set screws.

Note: Aiming will assist in measuring material in the cone.

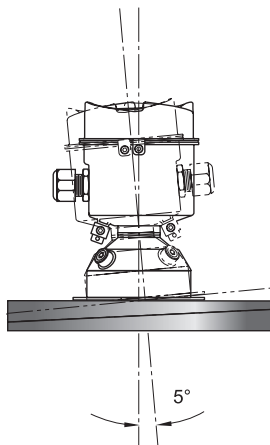
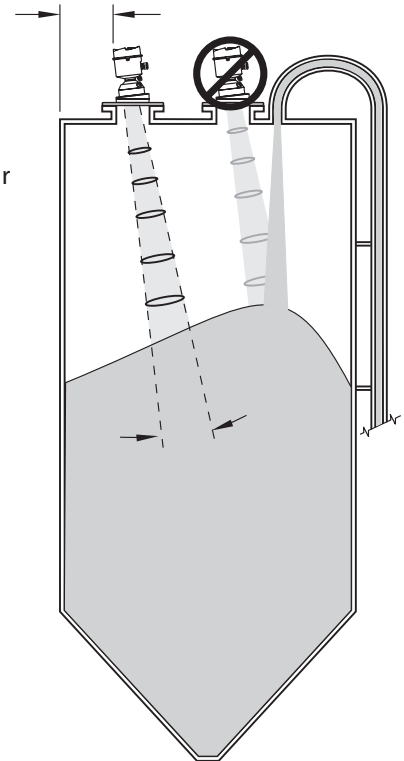

3-inch Directional Flange

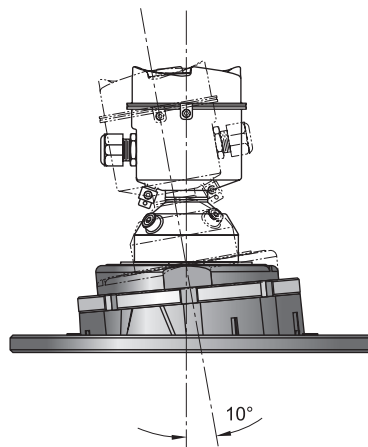

4 or 6-inch Aiming Flange

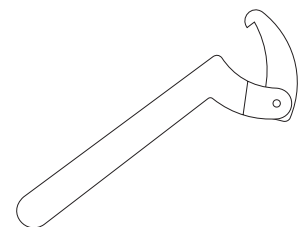

C-Spanner Wrench

REMOVEABLE DISPLAY

- The display can be rotated as required, to one of 4 positions, 90 degrees apart.
- It can also be used to transfer parameters from one device to another.
- Can be removed with power applied.

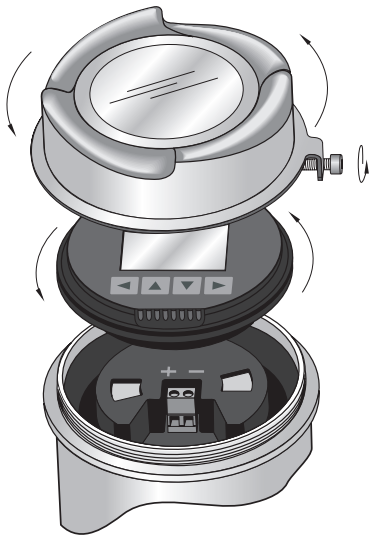

Sun Shield (Optional Accessory)

The MP Series air radar display can be protected by an optional sun shield if the instrument will be mounted in direct sunlight.

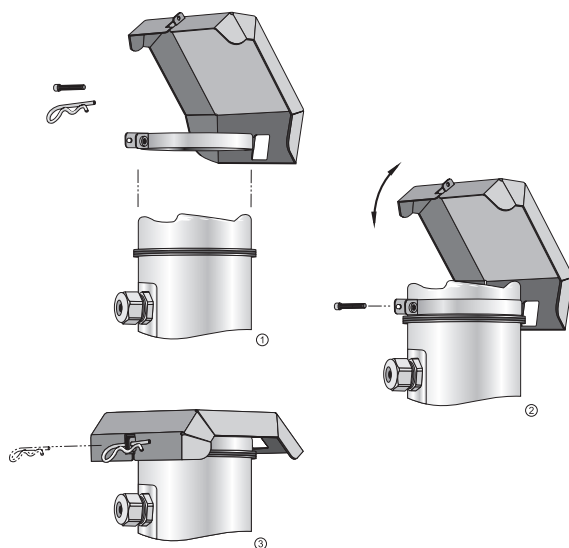

AIR PURGE

All MP Series air radar models come standard with an air purge inlet. For convenient cleaning, a purging inlet is provided above the antenna. The system provides an 1/8" inlet (female thread) above the antenna where clean, dry air passes to the face of the antenna lens to clean it. The customer will supply the purging air by a manual or automatic valve system.

- Purge duration, pressure, and interval, will vary with each application. It is the user's responsibility to determine the requirements depending on the application and cleaning required.
- Short duration bursts of high pressure provide more effective cleaning than continuous low pressure air.
- Some dust particles are highly abrasive and can cause wear on the lens face over time if continuous air purge is used, therefore short bursts are recommended.
- It is the customer's responsibility to ensure that any vacuum or pressure in the measured vessel is maintained, considering the hole that passes through the process connection and MP Series antenna system.

Acceptable Air Consumption
(Flow rate vs applied pressure)

Air Pressure (psi)	Approx. inlet volume flow rate (SCFM)
20	5
40	10
50	15
80	20
100	25
110	30

Recommended 90 to 110 psi for effective cleaning

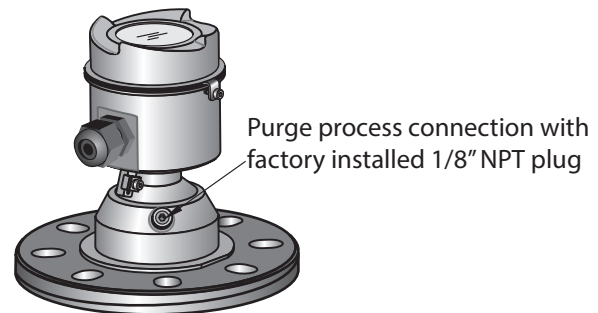

PURGE CONNECTION

- The purge connection is closed by the manufacturer, using a 1/8" plug (standard on all units).
- When the plug is removed to connect a purging system, the operator is responsible for ensuring that the purging circuit conforms to explosion protection requirements: for example, by fitting an NRV valve. Air pressure in vessel can affect purge operation.

PURGE AIRFLOW

- The purge airflow is designed to create a strong vortex of air that rapidly cleans the face of the lens.
- The air purge system can clean both dust and moisture off the lens.

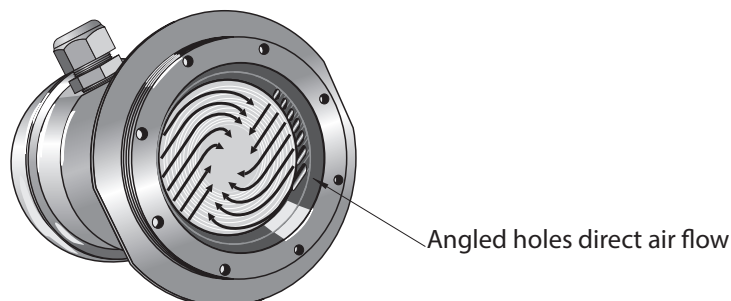

V. ELECTRICAL INSTALLATION



WARNING: REMOVE POWER FROM THE UNIT BEFORE INSTALLING, REMOVING, OR MAKING ADJUSTMENTS.



WARNING: THE DC INPUT TERMINALS SHALL BE SUPPLIED FROM A SOURCE PROVIDING ELECTRICAL ISOLATION BETWEEN THE INPUT AND OUTPUT, IN ORDER TO MEET THE APPLICABLE SAFETY REQUIREMENTS OF IEC 61010-1.



WARNING: ALL FIELD WIRING MUST HAVE INSULATION SUITABLE FOR RATED VOLTAGES.



WARNING: CHECK THE DEVICE LABEL ON YOUR INSTRUMENT, TO VERIFY THE APPROVAL RATING.



WARNING: USE APPROPRIATE CONDUIT SEALS TO MAINTAIN IP OR NEMA RATING.

GENERAL SAFETY

When using electrical equipment, you should always follow basic safety precautions, including the following:

- The installation and wiring of this product must comply with all national, federal, state, municipal, and local codes that apply.
- Properly ground the enclosure to an adequate earth ground.
- Do not modify any factory wiring. Connections should only be made to the terminals described in this section.
- Do not allow moisture to enter the electronics enclosure. Conduit should slope downward from the housing. Install drip loops and seal conduit with silicone rubber product.





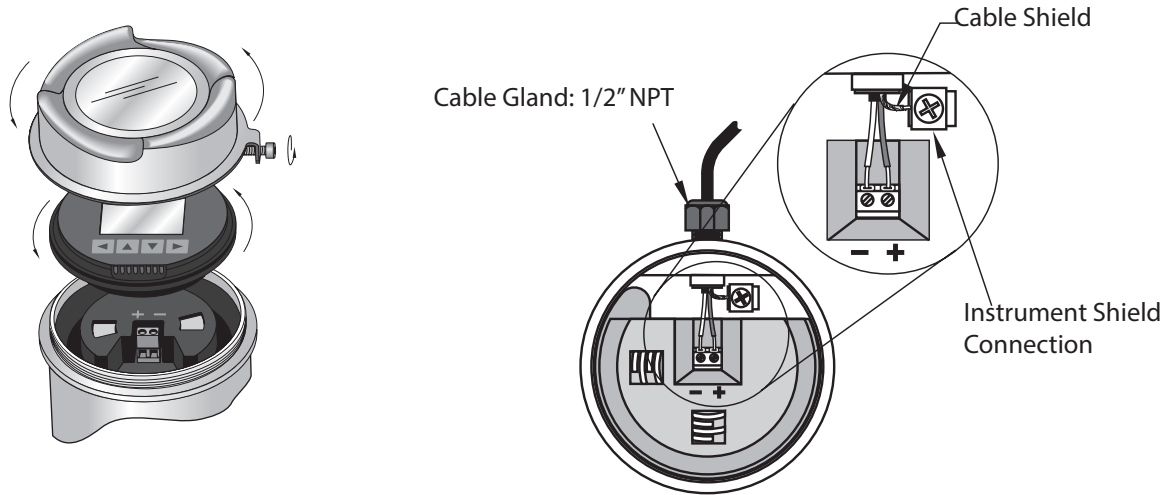

CONNECTING THE MP SERIES

1. Loosen locking screw.
2. Remove unit lid.
3. Remove optional display by gently turning the display a quarter turn counter-clockwise until it is free.
4. Strip the cable jacket for approximately 70 mm (2.75") from the end of the cable, and thread the wires through the gland. If cable is routed through conduit, use only approved suitable-size hubs for waterproof applications.
5. Connect the wires to the terminals as shown: the polarity is identified on the terminal block
6. Ground the instrument according to local regulations.
7. Tighten the gland to form a good seal.
8. Replace optional display and device lid.
9. Tighten locking screw.



HAZARDOUS CONNECTION

- SUBSTITUTION OF COMPONENTS MAY IMPAIR SUITABILITY FOR CLASS 1, DIVISION 2
- DO NOT DISCONNECT EQUIPMENT UNLESS POWER HAS BEEN SWITCHED OFF OR THE AREA IS KNOWN TO BE NON-HAZARDOUS
- INSTALLATION SHALL BE DONE IN ACCORDANCE WITH THE N.E.C. AND C.E.C. PART ONE
- USE APPROVED WATER TIGHT CONDUIT FITTINGS FOR OUTDOOR APPLICATIONS

POTENTIAL ELECTROSTATIC CHARGING HAZARD, DO NOT CLEAN WITH DRY CLOTH			AIR RADAR SERIAL NO.: GYZ / A1034567 ENCLOSURE: NEMA / TYPE 4X, 6; IP68	IC: 21136- AIR RADAR FCC ID: 2AHEN-AIR RADAR
DO NOT INSTALL WHERE BUILD-UP OF CHARGE IS LIKELY	CLASS II, DIV. 1, GR. E, F, G CLASS III, T4		AMB. TEMP. : - 40°C to 80°C INPUT : 24 V  NOM., 30 V  MAX., 4 - 20 mA OUTPUT: HART	THIS DEVICE COMPLIES WITH PART 15 OF THE FCC RULES. OPERATION IS SUBJECT TO THE FOLLOWING TWO CONDITIONS: 1) THIS DEVICE MAY NOT CAUSE HARMFUL INTERFERENCE AND 2) THIS DEVICE MUST ACCEPT ANY INTERFERENCE RECEIVED, INCLUDING INTERFERENCE THAT MAY CAUSE UNDESIRED OPERATION
USE SUITABLY RATED CABLE	CLASS I, DIV. 2 GR. A, B, C, D T4		 	
DE-ENERGIZE BEFORE REMOVING COVER	REFER TO INSTALLATION DWG. A5E37393148	VENTURE MEASUREMENT, SPARTANBURG, SC USA Assembled in Canada with domestic and imported parts		

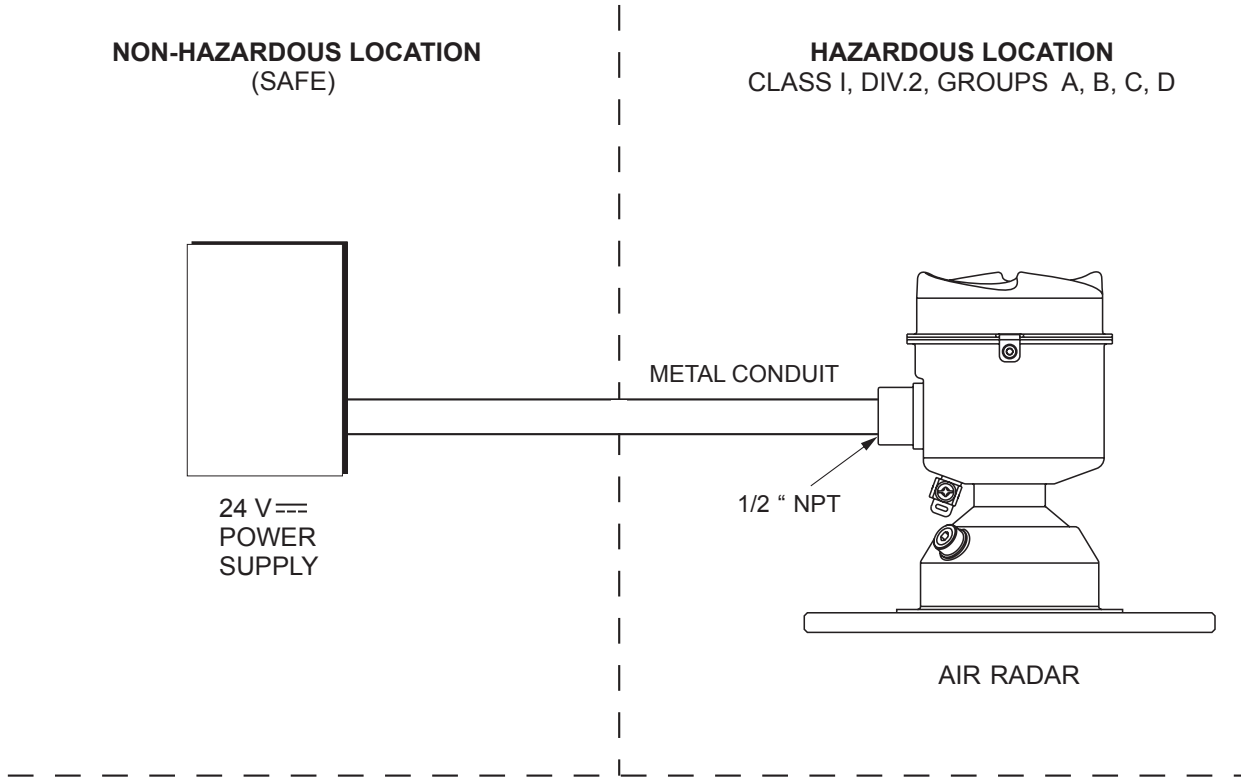

CONNECTING HART

Typical PLC/ mA configuration with HART

Depending on the system design, the power supply may be separate from the PLC, or integral to it.

HART resistance (total loop resistance, that is, cable resistance plus 250 Ohm (resistor) must be less than 550 Ohm for the device to function properly.

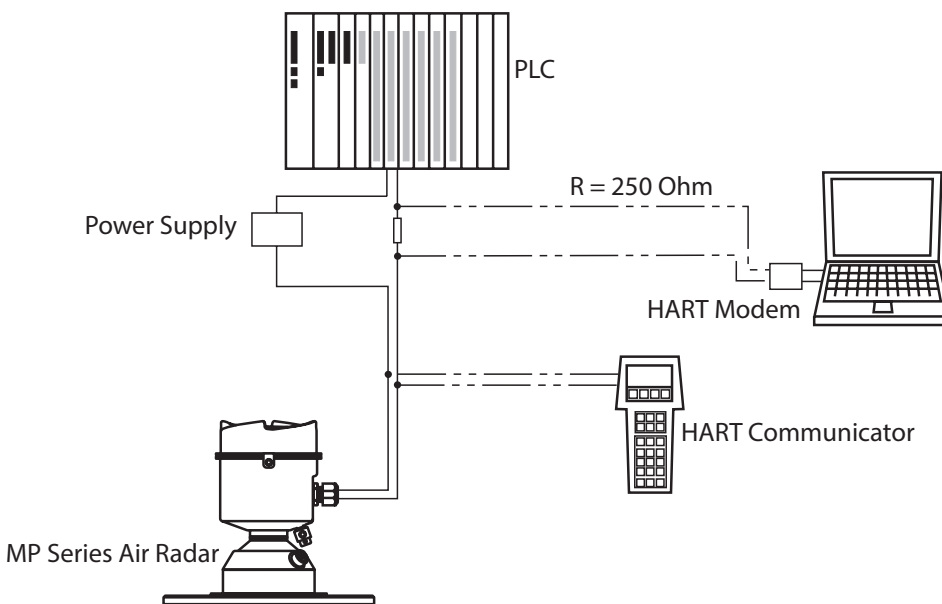

VI. SET-UP



WARNING: REMOVE POWER FROM THE UNIT BEFORE INSTALLING, REMOVING OR MAKING ADJUSTMENTS.



CAUTION: TO REDUCE THE RISK OF IGNITION IN HAZARDOUS ATMOSPHERES, DISCONNECT THE EQUIPMENT FROM SUPPLY CURCIUT BEFORE OPENING. KEEP ASSEMBLY TIGHTLY CLOSE WHEN IN OPERATION.

LOCAL DISPLAY

MP SERIES air radar carries out its level measurement tasks according to settings made via parameters. The settings can be modified locally via the optional Local Display Interface (LDI) which consists of an LCD display with buttons. A Quick Start Wizard provides an easy step-by-step procedure to help you configure the device for a simple application.

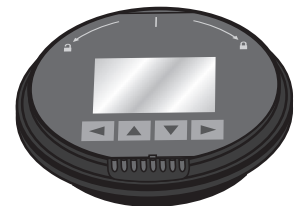

Once the device is powered up, a transition screen showing a progress bar is displayed. The first measurement is being processed during this time. The unit will automatically start up in Measurement Mode. The first time the device is configured, you will be prompted to select a language (English, German, French, Spanish or Chinese). To change the language again, see the Language Menu.

Measurement Mode Display: Normal Operation

1. Toggle indicator for primary value (PV) or secondary value (SV)

Press UP or DOWN arrow to switch

2. Selected operation: level, space or distance

3. Measured value (level, space or distance)

4. Units

5. Bar graph indicates level

6. Text area displays status messages

If fault is present, text area displays a fault code and an error message

7. Secondary region indicates on request electronics temperature, echo confidence, loop current, or distance

If fault is present, will display fault code or error message

8. Device status indicator

If fault is present, service required icon appears

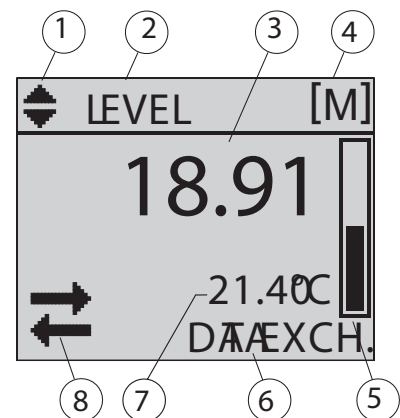

Program Mode Display: Navigation View

- A visible menu bar indicates the menu list is too long to display all items.
- The depth of the item band on the menu bar indicates the length of the menu list: a deeper band indicates fewer items.
- The position of the item band indicates the approximate position of the current item in the list. A band halfway down the menu bar indicates the current item is halfway down the list.

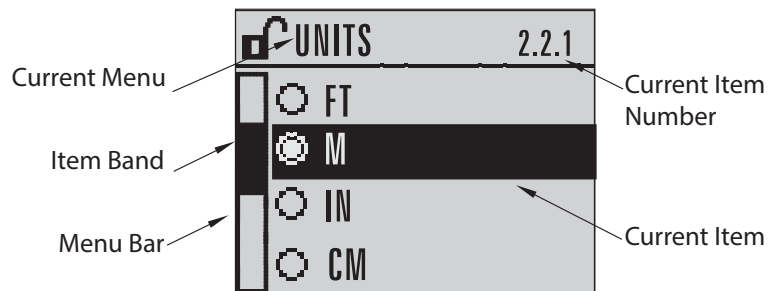

To enter into Program Mode, using the LDI buttons, press the RIGHT arrow key.

While the device is in Program Mode, the output remains active and continues to respond to changes in the device.

The unit will return to Measurement mode after a period of inactivity in Program Mode; set via Timeout Menu.

For a complete list of parameters, go to page XX.

Selecting an Option:

1. Navigate to the desired parameter using the menu and LDI buttons.
2. Press the RIGHT arrow key to open parameter view.
3. Press the RIGHT arrow key again to open the Edit mode. The current selection is highlighted; scroll to a new selection.
4. Press the RIGHT arrow key to accept it. The LCD returns to the parameter view and displays the new selection.

Changing a Numeric Value:

1. Navigate to the desired parameter.
2. Press the RIGHT arrow key to open parameter view. The current value is displayed.
3. Press the RIGHT arrow key again to open the Edit mode. The current value is highlighted.
4. Use the arrow keys to edit the value.

UP and DOWN arrows will go through numbers 0 through 9 then (.), (#), and (>)

5. Continue to press the RIGHT arrow key to get to the far right to accept the value. The LCD returns to parameter view and displays the new value.

QUICK START WIZARD VIA LCD PUSH BUTTONS

1. Press RIGHT arrow to enter Program mode.
2. Choose Quick Start (1) and then Quick Start Wizard (1.1)
3. Follow the steps then choose Finish to save Quick Start parameter changes (shown below) and return to Program menu or press LEFT arrow to return to Measurement mode.

To Add or Delete Digits Using Push Buttons:

NOTE: When the 'ENTER' icon is highlighted, press the UP arrow to insert a digit on the right, press the DOWN arrow to delete the right-most digit, press the RIGHT arrow to accept the value, or the LEFT arrow to cancel.

1. Navigate to the parameter you wish to modify and press RIGHT arrow to edit it. The value will be highlighted.
2. Press UP arrow or DOWN arrow to delete the highlighted value, or LEFT arrow to modify the value from the left-most digit, starting with the plus/minus sign.
3. With the plus or minus sign highlighted, press UP arrow or DOWN arrow to change it. Press RIGHT arrow to highlight the next digit to the right.
4. Use UP arrow or DOWN arrow to modify the highlighted digit. Scroll past 9 to reach the decimal point.
5. When the value is complete, press RIGHT arrow until the ENTER icon is highlighted, then press RIGHT arrow to accept the value.

To modify a text string:

1. Navigate to the parameter you wish to modify and press RIGHT arrow to edit it. The string will be highlighted.
2. Follow the same steps as above, to add, delete, or modify characters.

QUICK START WIZARD:

1. Press RIGHT arrow to activate PROGRAM model and open menu level 1.
2. Press RIGHT arrow twice to navigate to menu item 1.1 and open the Quick Start Wizard.
3. At each step, press DOWN arrow to accept default values and move directly to the next item, OR press RIGHT arrow to open EDIT mode: the current selection is highlighted.
4. Scroll to desired item and press RIGHT arrow to store the change, then press the DOWN arrow to continue.

At any time, you can press UP arrow to go back, or LEFT arrow to cancel.

Once the six parameters of the Quick Start Wizard have been added - see next page, press the DOWN arrow to finalize and save to complete the wizard.

Press LEFT arrow to return to Measurement Mode.

QUICK START WIZARD PARAMETER SHEET

The following six parameters are needed to use the Quick Start Wizard; this page can be printed for easy set-up.

VESSEL (QUESTION 1)

Select vessel construction material:

- STEEL
- CONCRETE

RESPONSE RATE (QUESTION 2)

Sets the reaction speed of the device to measurement changes in the target range.

Response Rate	Vessel Fill Rate/Min or Empty Rate/Min
SLOW	0.32 ft/min (0.1 m/min)
MED	3.28 ft/min (1.0 m/min)
FAST	32.8 ft/min (10.0 m/min)

Use a setting just faster than the maximum vessel filling or vessel emptying rate (whichever is greater)
MED response rate is set as the Default.

UNITS (QUESTION 3)

Sensor measurement units:

- Meters (m) - DEFAULT
- Centimeters (cm)
- Millimeters (mm)
- Feet (ft)
- Inches (in)

OPERATION (QUESTION 4)

Operation	Description
LEVEL (1)	Distance from Low Calibration Point to material surface
SPACE (2)	Distance from High Calibration Point to material surface
DISTANCE (3)	Distance from Sensor Reference Point to material surface (flange face)

LOW CALIBRATION POINT (QUESTION 5)

Distance from Sensor Reference Point to Low Calibration Point: usually process empty level.

Value Range: 0.000 to 40.000 m or 0.000 to 100.000 m
(Default: 40.000 m or 100.000 m)

HIGH CALIBRATION POINT (QUESTION 6)

Distance from Sensor Reference Point to High Calibration Point: usually process full level.

Value Range: 0.000 to 40.000 m or 0.000 to 100.000 m
(Default: 40.000 m or 100.000 m)

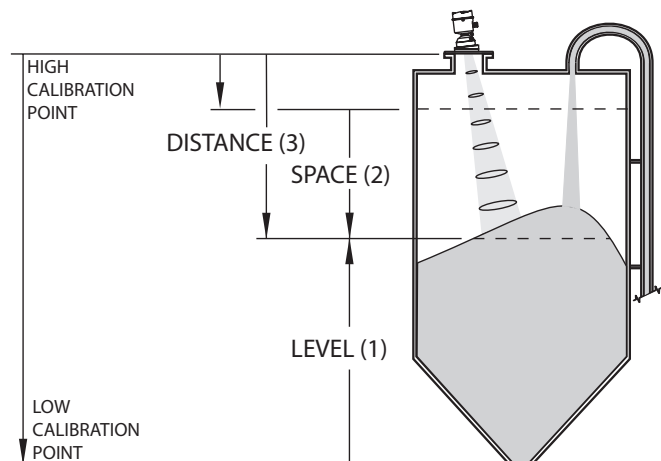

High Point minus Low Point must not be less than zero or error will occur.

LEVEL APPLICATION EXAMPLE

The application is a vessel that takes an average 3 hours (180 minutes) to fill and 3 weeks to empty.

Fill rate = 0.08 m/minute [(Low Cal Pt. minus High Cal Pt)/fastest of fill or empty time]

$$= (15.5 \text{ m} - 1 \text{ m}) / 180 \text{ min.}$$

$$= 14.5 \text{ m} / 180 \text{ min.}$$

$$= 0.08 \text{ m/min}$$

Therefore SLOW response rate (0.1 m/min) can be selected.

Quick Start Parameter	Setting	Description
Vessel	STEEL	Selects vessel construction material.
Response Rate	SLOW	Resets Fill Rate/ Empty Rate to 0.1 m/minute.
Units	M	Sensor measurement units.
Operation	LEVEL (1)	Material level referenced from Low Cal. Point.
Low Calibration Point	15.5	Process empty level.
High Calibration Point	1.0	Process full level.

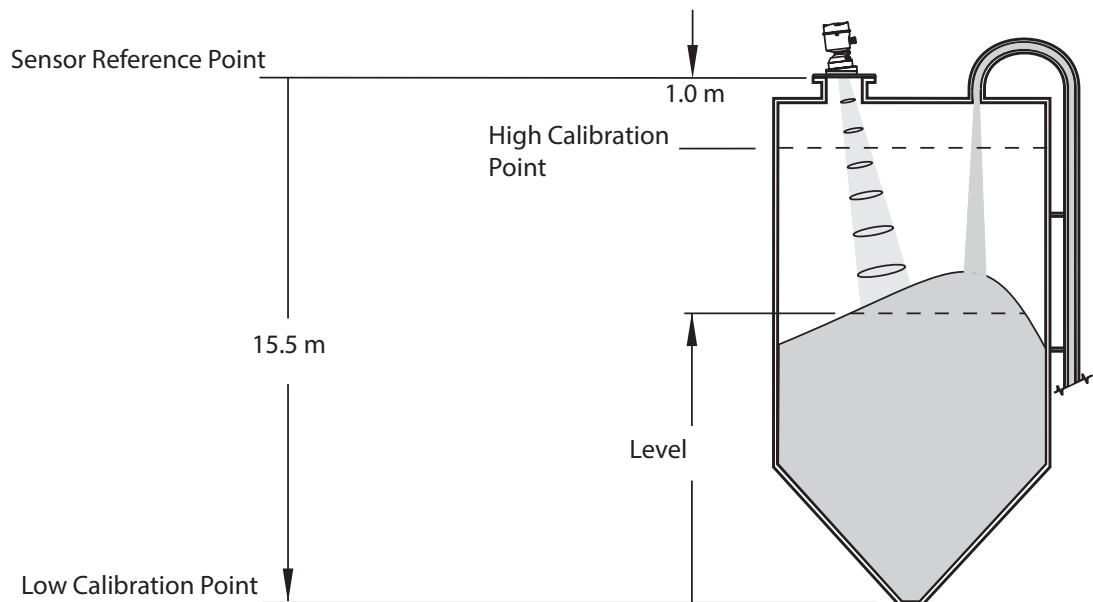

REQUESTING AN ECHO PROFILE

1. In Program mode, navigate to Level Meter > Diagnostics (3) > Echo Profile (3.2)
2. Press RIGHT arrow to request a profile.
3. Use UP and DOWN arrows to scroll to an icon on the right of the screen. When an icon is highlighted, that feature becomes active.
4. To move a cross-hair, press RIGHT arrow to increase the value, LEFT arrow to decrease.
5. To Zoom into an area, position the intersection of the cross-hairs at the center of that area, select Zoom, and press RIGHT arrow . Press LEFT arrow to Zoom out.
6. To update the profile, select Measure and press RIGHT arrow.
7. To return to the previous menu, select Exit then press RIGHT arrow.

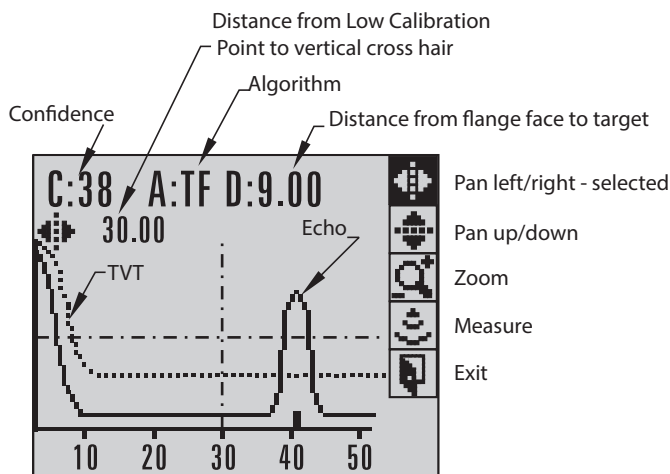

DEVICE ADDRESS

In PROGRAM mode, navigate to: Level Meter > Communication (5) > Device Address (5.2) to view the device address.
 Press MODE to return to Measurement mode.

PARAMETER DETAILS

1.2 AFES (AUTO FALSE ECHO SUPPRESSION) WIZARD

Note: Before using AFES, configure the device via the Quick Start wizard.

If you have a vessel with known obstructions, we recommend using AFES to prevent false echo detection.

This feature can also be used if the unit displays a false high level, or the reading is fluctuating between the correct level and a false high level.

1. Make sure the material level is below all known obstructions.
2. Navigate to Level Meter > Diagnostics (3.) > Echo Profile (3.2.) and press RIGHT arrow to request a profile.
3. Determine a range that includes the false echo but not the true echo: in the example, 3.3 m.
4. Open the AFES wizard and press DOWN arrow to continue.
5. Press RIGHT arrow to edit Auto False Echo Suppression Range.
6. Enter the new range value and press RIGHT arrow to transfer it.
7. Press DOWN arrow to initiate learn. A transition screen appears, followed by the message 'Wizard Complete'.
8. Press DOWN arrow (Finish) to save AFES parameter changes and return to Program menu.
9. Navigate to Echo Profile (3.2) and press RIGHT arrow to request a profile. The false echo is now screened out and the true echo selected.
10. Press LEFT arrow key to return to Measurement Mode.

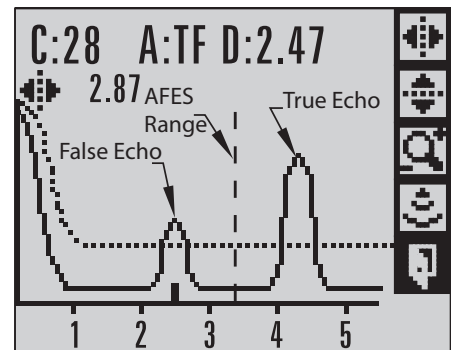

1.3 COPY PARAMETERS TO DISPLAY

Transfer parameter settings from a device to the local display interface.

1. Press RIGHT arrow to edit.
2. Press DOWN arrow to select START and RIGHT arrow key to begin the transfer.
3. PARAM UPLOAD will be displayed, then the device returns to Measurement Mode.

1.4 COPY PARAMETERS FROM DISPLAY

Transfer parameter settings from the local display interface to a device.

1. Press RIGHT arrow to edit.
2. Press DOWN arrow to select START and RIGHT arrow key to begin the transfer.
3. PARAM DOWNLOAD will be displayed, then the device returns to Measurement Mode.

1.5 COPY FIRMWARE TO DISPLAY

Transfer firmware from a device to the local display interface.

1. Press RIGHT arrow to edit.
2. Press DOWN arrow to select START and RIGHT arrow key to begin the transfer.
3. SW UPLOAD will be displayed, then the device returns to Measurement Mode.

1.6 COPY FIRMWARE FROM DISPLAY

Transfer firmware from the local display interface to a device. Do NOT interrupt power during transfer.

1. Press RIGHT arrow to edit.
2. Press DOWN arrow to select START and RIGHT arrow key to begin the transfer.
3. SW DOWNLOAD will be displayed, then the device returns to Measurement Mode.

2. SETUP

Default settings are noted by asterisk (*) unless explicitly stated.

2.1 Device

2.1.1 Long Tag: Text can be used in any way. A recommended use is as a unique label for a field device in a plant.

Limited to 32 ASCII characters. Read only on device. Read/write using SIMATIC PDM and AMS.

2.1.2 Tag: Text that can be used in any way. A recommended use is as a unique label for a field device in a plant.

Limited to 8 ASCII characters. Read only on device. Read only on device. Read/write using SIMATIC PDM and AMS.

2.1.3 Descriptor: Text that can be used in any way. Limited to 16 ASCII characters. No specific recommended use. Read only on device. Read only on device. Read/write using SIMATIC PDM and AMS.

2.1.4 Message: Text that can be used in any way. Limited to 32 ASCII characters. No specific recommended use. Read only on device. Read only on device. Read/write using SIMATIC PDM and AMS.

2.1.5 Installation Date: Date the device was first commissioned. Read only locally. Can be written via HART (dd mm yyyy)

2.1.6 Hardware Revision: Read only. Corresponds to the electronic hardware of the unit.

2.1.7 Firmware Revision: Read only. Corresponds to the firmware that is embedded in the unit.

2.1.8 Loader Revision: Read only. Corresponds to the software used to update the unit.

2.1.9 Menu Timeout: Time menu stays visible before switching back to Measurement view if no key is pressed
Values Range from 15 to 65535 s; Default is 120 s

2.2 Sensor

2.2.1 Units: PV (Primary Value) and SV (Secondary Value) units. Used in setting High/Low Calibration Point and displayed on LCD and in PDM

Values: meter*, centimeter, millimeter, ft, in, percentage

Changing units to percent (%) will update the mA setpoints.

2.2.2 Sensor Mode

Mode	Description
LEVEL	Distance from Low Calibration Point to material surface
SPACE	Distance from High Calibration Point to material surface
DISTANCE *	Distance from Sensor Reference Point to material surface (flange face)

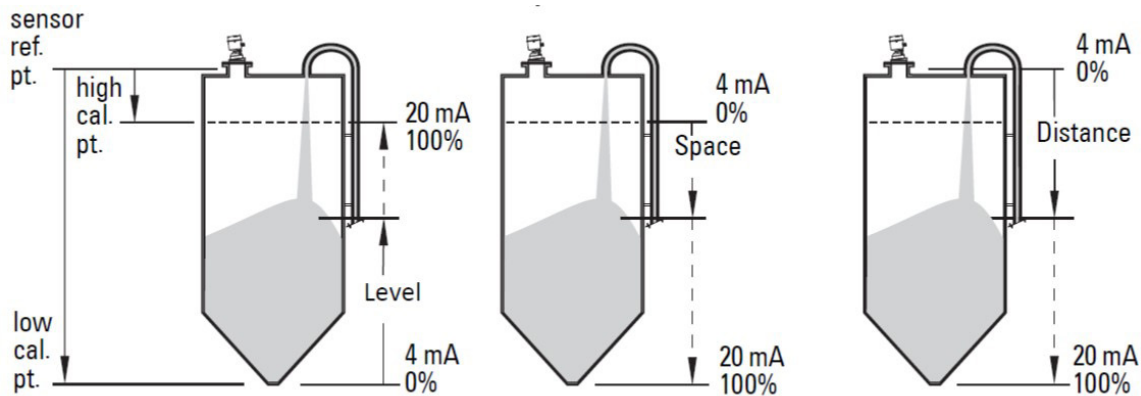

2.2.3 Damping Filter: The time constant for the damping filter. The damping filter smooths out the response to a sudden change in level. This is an exponential filter and the engineering unit is always in seconds.

Value Range: 0 to 1500 s; Default is 10 s

2.2.4 Temperature Units: Selects the engineering units to be displayed with the value representing temperature.

Options: C*, F, R or K

2.5.5 Unit: Sensor measurement units.

2.3 Calibration - We recommend using the Quick Start Wizard to configure the device

2.3.1 Low Calibration Point: Distance from sensor reference point to Low Calibration Point. Units are defined in Units (2.2.1) and displayed on the LCD.

Value Range: 0 to 100.00 m; Default 100.00 m

Any change to Low Calibration Point will cause the mA setpoints to be updated.

2.3.2 High Calibration Point: Distance from sensor reference point to High Calibration Point. Units are defined in Units (2.2.1) and displayed on the LCD.

Value Range: 0 to 100.00 m; Default 100.00 m

Any change to Low Calibration Point will cause the mA setpoints to be updated.

When setting the High Calibration Point value, note that echoes are ignored within Near Range.

2.3.3 Sensor Offset: A constant offset (negative or positive) that can be added to sensor value to compensate if the sensor reference point has shifted. (For example, this could result from adding a thicker gasket or reducing the standoff/nozzle height).

Value Range: -100 to 100 m; Default 0.00 m

2.4 Rate

2.4.1 Reponse Rate: Sets the reaction speed of the device to measurement changes.

Response Rate	Vessel Fill Rate/Min or Empty Rate/Min	Damping Filter
SLOW	0.32 ft/min (0.1 m/min)	10 s
MED	3.28 ft/min (1.0 m/min)	10 s
FAST	32.8 ft/min (10.0 m/min)	0 s

Use a setting just faster than the maximum filling/emptying rate (whichever is faster).

2.4.2 Fill Rate/Min: Defines the maximum rate at which the reported sensor value is allowed to increase. Allows you to adjust the unit response to increases in the actual material level. Fill Rate is automatically updated whenever Response Rate is altered.

Response Rate	Fill Rate
SLOW	0.32 ft/min (0.1 m/min)
MED	3.28 ft/min (1.0 m/min)
FAST	32.8 ft/min (10.0 m/min)

2.4.3 Empty Rate/Min: Defines the maximum rate at which the reported sensor value is allowed to decrease. Allows you to adjust the unit response to increases in the actual material level. Fill Rate is automatically updated .. whenever Response Rate is altered.

Response Rate	Empty Rate
SLOW	0.32 ft/min (0.1 m/min)
MED	3.28 ft/min (1.0 m/min)
FAST	32.8 ft/min (10.0 m/min)

2.5 Fail-Safe

2.5.1 Material Level: Defines the mA output to use when the Fail-Safe Timer expires

HI	20.5 mA (max mA limit)
LO	3.8 mA (min mA limit)
HOLD	Last valid reading; Default; 22.6 mA
VALUE	User selected value (Define in Level 2.5.3); Default 3.58 mA

2.5.2 Timer: Sets the time to elapse since the last valid reading, before the Fail-Safe Level is reported
Value Range: 0.00 to 720 s; Default 100 s

2.5.3 Level: Allows the user to define the mA value to be reported when the Fail-Safe timer expires.
Value Range: 3.56 mA to 22.6 mA; Default 3.56 mA

2.6 Analog Output Scaling

- Level, space and distance have different reference points (See page 21 for reference diagram)
- Use caution when changing Current Output Function while the device is connected to a HART network. Current Output Function will update the mA Setpoints.
- Current Output Function also affects the secondary, tertiary and quaternary variables in a HART network.

Options	Reference Point	Description
Level	Low Calibration Point	Measured as a percentage of the different between High Calibration Point and Low Calibration Point
Space	High Calibration Point	
Distance	Sensor Reference Point	Measured as a percentage of Low Calibration Point

2.6.2 4 mA Setpoint: Sets the process level corresponding to the 4mA value. 4 mA always defaults to 0, and Current Output Function (2.6.1) determines whether this is a Level, Space or Distance measurement.

Value Range: -999999 to +999999; Default 0.00 m

- Enter the reading that is to correspond to 4 mA output
- Units are defined in Units (2.2.1)

2.6.3 20mA Setpoint: Sets the process level corresponding to the 20 mA value. 20 mA always defaults to 100%, and Current Output Function (2.6.1) determines whether this is a Level, Space or Distance measurement.

Value Range: -999999 to +999999; Default 40.00 or 100.0 m

- Enter the reading that is to correspond to 20 mA output
- Units are defined in Units (2.2.1)

2.6.4 Min. mA Limit: Prevents the mA output from dropping below this minimum level for a measurement value. This does not restrict the Fail-Safe or Manual settings.

Value Range: 3.56 to 22.6 mA; Default 3.80 mA

2.6.5 Max mA Limit: Prevents the mA output from dropping below this maximum level for a measurement value. This does not restrict the Fail-Safe or Manual settings.

Value Range: 3.56 to 22.6 mA; Default 20.50 mA

2.6.6 mA Output Mode: Can be set to Manual or Auto

Options	Description
Manual	User can enter mA value for loop current.
Auto*	Loop current will follow measurement value.
Fixed	Read only. Loop current is set to the multidrop level of 4 mA. Can be selected or cancelled only via HART command 6.

2.6.7 Manual Value: Allows you to use a simulated value to test the functioning of the loop. You can enter 4 mA, 20 mA or any other user-defined value within the range.

Value Range: 3.56 to 22.6 mA

1. First set mA Output Mode (2.6.6) to Manual
2. Enter the desired mA value in mA Output Value
3. After completing the test, remember to reset mA Output Mode (2.6.6) to previous setting.

2.6.8 mA Output Value: Allows you to view the simulated value to test the functioning of the loop. Read Only

2.7 Signal Processing

2.7.1 Near Range: The range in front of the device (measured from the sensor reference point) within which any echoes will be ignored. This is sometimes referred to as blanking or a dead zone.

Value Range: 0 to 105 m (0 to 344.5 ft); Default 0.278 m (0.91 ft)

2.7.2 Far Range: Allows the material level to drop below Low Calibration Point without generating a Loss of Echo (LOE) state. Far Range can extend beyond the bottom of the vessel. Use this feature if the measured surface can drop below the Low Cal. Point in normal operation.

Values: Range Min = Low Calibration Point

Max = 105 m (344 ft)

Default: Value for Low Calibration Point + 5 m (16.4 ft)

2.7.3 Echo Select

2.7.3.1 Algorithm: Selects the algorithm to be applied to the echo profile to extract the true echo.

ALF	Area Largest First
A	Echo Area
L	Largest Echo
F	First Echo; Default
AL	Echo Area Largest
AF	Echo Area First
LF	Echo Largest First
BLF	Best of First and Largest Echo
BL	Best Largest Echo
BF	Best First Echo
	LAST
TF	True First Echo

2.4.3.2 Echo Threshold: Sets the minimum echo confidence that the echo must meet in order to prevent a Loss of Echo condition and the expiration of the Fail-safe (LOE) timer. When Confidence (2.7.6.1) exceeds Echo Threshold (2.7.3.2) the echo is accepted as a valid echo and is evaluated. Use this feature when an incorrect material level is reported.

Value Range: 0 to 99; Default 5

2.7.3.3 Position Detect: Selecting Steel or Concrete vessel type in the Quick Start Wizard changes the settings for Position Detect (2.7.3.3) to Rising Edge. Defines where on the echo the distance measurement is determined. See Shaper Mode (2.8.4) for more details. If the vessel bottom is being reported as the level instead of the actual material level (at low conditions), we recommend setting Position to Hybrid using it in combination with CLEF Range (2.7.3.4)

RISING (yields highest stability on sloped targets); Default

CENTER (yields higher accuracy on flat, non-sloped targets)

HYBRID (CENTER and CLEF)

CLEF (Constrained Leading Edge Fit)

2.7.3.4 CLEF Range: The CLEF algorithm is used mainly to allow correct level reporting for low dK materials which may otherwise cause an incorrect reading in an empty or almost empty vessel. It is used from Far Range up to the level defined by CLEF Range. Above that point, the Center algorithm is used.

- CLEF Range is referenced from Far Range
- The value for the CLEF Range must include the difference between Far Range and Low Calibration Point, plus any level above the Low Calibration Point to be managed by the CLEF algorithm.

Value Range: 0 to 45 m for 40 m units; 0 to 105 m for 100 m units; Default 0.0 m

2.7.3.5 Echo Marker: The point on the selected echo from which the measured value is taken. Use this feature if the reported material level fluctates slightly due to a variable rise in the leading edget of the true echo on the Echo Profile. Enter the value (in percent of echo height) to ensure the Echo Lock window intersects the Echo Profile at the sharpest rising position of the Echo Profile representing the true echo.

Value Range: 5 to 95%; Default is 70%

2.7.4 Sampling: Provides a method of checking the reliability of a new echo before accepting it as the valid reading, based on numbers of samples above or below the currently selected echo.

2.7.4.1 Echo Lock: Selects the measurement verification process.

Lock Off

Maximum Verification (Not recommended for radar)

Material Agitator; Default

Total Lock (Not recommended for radar)

2.7.4.2 Up Sampling: Specifies the number of consecutive echoes that must appear above the echo currently selected, before the measurement is accepted as valid.

Value Range: 1 to 50; Default is 5

2.7.4.3 Down Sampling: Specifies the number of consecutive echoes that must appear below the echo currently selected, before the measurement is accepted as valid.

Value Range: 1 to 50; Default is 2

2.7.4.4 Echo Lock Window: A distance window centered on the echo is used to dervie the reading. When a new measurement is in the window, the window is re-centered and the reading is calculated. When the value is 0, the window is automatically calculated after each measurement.

- For slower Measurement Response values, the window grows at a slower rate.
- For faster Measurement Response values, the window grows at a faster rate

Value Range: 0 to 45 m; Default is 0 m

2.7.5 Filtering

2.7.5.1 Narrow Echo Filter: Filters out echos of a specific width. To remove a false echo from the Echo Profile, take i its width in mm and multiply by 0.006. Enter the result. When a value is keyed in, the nearest acceptable value is entered.

Range: 0 to 255

0 = OFF

greater = wider

2.7.5.2 Reform Echo: Smooths jagged peaks in the echo profile. Reforms fragmented echos into one echo

0 = OFF
greater = wider
Range: 0 to 255 samples
Recommended 10 samples

2.7.5.3 Average Amount: The fraction of the old shot data that is kept for averaging purposes. A higher value will give a smoother profile at the expense of a slower echo profile response.

Values: 0.0 to 1.0; Default 0.75

2.7.6 Echo Quality

2.7.6.1 Confidence: Indicates echo reliability: higher values represent better echo quality. The display shows the echo confidence of the last measurement. Echo Threshold (2.7.3.2) defines the minimum criterion for echo confidence.

Values: 0 to 99

2.7.6.2 Echo Strength: Displays the absolute strength in dB above 1 uV rms) of the echo selected as the measurement echo.

Values: -20 to 99

2.8 TVT Setup

2.8.1 Auto False Echo Suppression: Recommend setting via local operation using the Auto False Echo Suppression Wizard. Used together with Shaper Mode (2.8.4) to screen out false echos in a vessel with known obstructions. A 'learned TVT (time varying threshold) replaces the default TVT over a specified range.

2.8.2 Auto False Echo Suppression Range: Defines the endpoint of the Learned TVT distance. Units are defined in Units (2.2.1) Used in combination with Auto False Echo Suppression.

Value Range: 0.00 to 45.00 or 105.00 m (depending on model); Default 1.00 m

2.8.3 Hover Level: Defines how high the TVT (Time Varying Threshold) is placed above the noise floor of the echo profile, as a percentage of the difference between the peak of the largest echo in the profile and the noise floor.

Value Range: 0 to 100%; Default 40%

2.8.4 Shaper Mode: Enables/Disables the TVT shaper. ON or OFF; Default is OFF

2.9 TVT Shaper: Adjusts the TVT (Time Varying Threshold) at a specific range (breakpoint on the TVT). This allows you to reshape the TVT to avoid unwanted echoes. There are 120 breakpoints.

Value Range: -50 to 50 dB; Default 0 dB

To use via LDI

1. Go to Shaper Mode (2.8.4) and Select ON
2. Go to Breakpoint 1-9 (2.9.1)
3. Open Shaper 1 and enter the TVT Offset value (between -50 and 50)
4. Go to the next Shaper point and repeat steps 3 and 4 till all desired breakpoint values have been entered.

2.9.1 Breakpoint 1-9

2.9.2 Breakpoint 10-18

2.9.3 Breakpoint 19-27

2.9.4 Breakpoint 28-36

2.9.5 Breakpoint 37-45

2.9.6 Breakpoint 46-54

2.9.7 Breakpoint 55-63

2.9.8 Breakpoint 64-72

2.9.10 Breakpoint 73-81

2.9.11 Breakpoint 82-90

2.9.12 Breakpoint 91-99

2.9.13 Breakpoint 100-108

2.9.14 Breakpoint 109-117

2.9.15 Breakpoint 118-120

2.10 Measured Values: Read only. Allows you to view measured values for diagnostic purposes.

2.10.1 Main Output: The value for Level/Volume, always displayed here in percent

2.10.2 Output No Linearization: The value for Level, always displayed here in percent

2.10.3 Output No Offsets: The value for distance, displayed in sensor units.

3. Diagnostics

3.1 Fault Reset: Clears the following fault

3.2 Echo Profile: Allows you to request the current echo profile

3.3 Trend: Shows current trend

3.4 Peak Values

3.4.1 Min Measured Value: The minimum recorded sensor value, reported in units.

3.4.2 Max Measured Value: The maximum recorded sensor value, reported in units.

3.4.3 Minimum PV: The minimum recorded Primary Value from the Analog Input Function Block 1.

3.4.4 Maximum PV: The maximum recorded Primary Value from the Analog Input Function Block 1.

3.4.5 Minimum SV: The minimum recorded Secondary Value from the Analog Input Function Block 1.

3.4.6 Maximum SV: The maximum recorded Secondary Value from the Analog Input Function Block 1.

3.5 Electronics Temperature

3.5.1 Min value: Displays (in Celcius) the minimum temperature recorded by the internal electronics. The high and low values are maintained over a power cycle.

3.5.2 Max Value: Displays (in Celcius) the maximum temperature recorded by the internal electronics. The high and low values are maintained over a power cycle.

3.5.3 Internal Temperature: Read only. Displays (in Celcius) the current temperature on the circuit board recorded by the internal electronics.

3.6 Remaining Device Lifetime

- Four sets of parameters allow you to monitor the Device/Sensor Lifetimes and set up Maintenance/Service schedules, based on operating hours instead of a calendar-based schedule.
- Performing a reset to Factory Defaults will reset all the Maintenance schedule parameters to their factory defaults.
- The device operates in years.

The device tracks itself based on operating hours and monitors its predicted lifetime. You can modify the expected device lifetime, set up schedules for maintenance reminders, and acknowledge them. The maintenance warnings and reminders are available through HART communications. This information can be integrated into an Asset Management system.

3.6.1 Time in Operation: Read only. The amount of time the device has been operating.

3.6.2 Remaining Lifetime: Read only. Lifetime Expected (3.6.6) less Time in Operation (3.6.1)

3.6.3 Reminder 1 (Required): If remaining lifetime (3.6.2) is equal or less than this value, the device generates a Maintenance required reminder.

Value Range: 0 to 20 years; Default 0.164 years

3.6.4 Reminder 2 (Demanded): If remaining lifetime (3.6.2) is equal or less than this value, the device generates a Maintenance required reminder.

Value Range: 0 to 20 years; Default 0.019 years

3.6.5 Reminder Activation: Allows you to enable a maintenance reminder

Reminder 1 (Maintenance Required)
Reminder 2 (Maintenance Demanded)
Reminders 1 and 2
OFF (Default)

3.6.6 Lifetime Expected: Allows you to override the factory default.

Value Range: 0 to 20 years; Default 10 years

3.6.7 Maintenance Status: Indicates which level of maintenance reminder is active.

3.6.8 Acknowledge Status: Indicates which level of maintenance reminder has been acknowledged.

3.6.9 Acknowledge: Acknowledges the current maintenance reminder.

1. Press RIGHT arrow key twice to open parameter view and activate EDIT mode
2. Press RIGHT arrow key to acknowledge the reminder

3.7 Remaining Sensor Lifetime

- Four sets of parameters allow you to monitor the Device/Sensor Lifetimes and set up Maintenance/Service schedules, based on operating hours instead of a calendar-based schedule.
- Performing a reset to Factory Defaults will reset all the Maintenance schedule parameters to their factory defaults.
- The device operates in years.

The device monitors the predicted lifetime of the sensor (the components exposed to the vessel environment). You can modify the expected sensor lifetime, set up schedules for maintenance reminders, and acknowledge them.

3.7.1 Time in Operation: Read only. The amount of time the sensor has been operating.

3.7.2 Remaining Lifetime: Read only. Lifetime Expected (3.7.6) less Time in Operation (3.7.1)

3.7.3 Reminder 1 (Required): If remaining lifetime (3.7.2) is equal or less than this value, the device generates a . Maintenance required reminder.

Value Range: 0 to 20 years; Default 0.164 years

3.7.4 Reminder 2 (Demanded): If remaining lifetime (3.7.2) is equal or less than this value, the device generates a Maintenance required reminder.

Value Range: 0 to 20 years; Default 0.019 years

3.7.5 Reminder Activation: Allows you to enable a maintenance reminder

Reminder 1 (Maintenance Required)

Reminder 2 (Maintenance Demanded)

Reminders 1 and 2

OFF (Default)

3.7.6 Lifetime Expected: Allows you to override the factory default.

Value Range: 0 to 20 years; Default 10 years

3.7.7 Maintenance Status: Indicates which level of maintenance reminder is active.

3.7.8 Acknowledge Status: Indicates which level of maintenance reminder has been acknowledged.

3.7.9 Acknowledge: Acknowledges the current maintenance reminder.

1. Press RIGHT arrow key twice to open parameter view and activate EDIT mode
2. Press RIGHT arrow key to acknowledge the reminder

4. Service

4.1 Demo Mode: Used to set up for demonstrations; reduces the time between measurements and the accuracy for demonstration purposes.

Values: ON or OFF; Default OFF

4.2 Master Reset:

- Following a reset to Factory Defaults, the LCD displays the Quick Start Wizard
- Following a reset to Factory Defaults, complete reprogramming is required.

Resets all parameters to factory defaults, with certain exceptions. The list of exceptions include, but is not limited to:

- Language
- Identification parameters (such as Tag, Installation Date)
- Device Address
- Write Protection
- Auto False Echo Suppression
- Auto False Echo Suppression Range

4.3 Powered Hours: Read only unless Write Protection (6.1) is set to Unlock (2457). Displays the number of hours the unit has been powered up since manufacture.

4.4 Power-on Resets: Read only unless Write Protection (6.1) is set to Unlock (2457). The number of power cycles that have occurred since manufacture.

4.5 LCD Backlight: Time the backlight remains on.

Range: 0 (backlight off) to 128 seconds; Default 128 seconds

4.6 LCD Contrast: The factory setting is for optimum visibility at room temperature and in average light conditions. Extremes of temperature will lesson the contrast.

Range: 0 to 20; Default 8 - Contrast setting will depend on ambient temperature.

4.7 Service Schedule: The device tracks service intervals based on operating hours and monitors the predicted lifetime to the next service. You can modify the Total Service Interval, set schedules for maintenance reminders and acknowledge them. The maintenance warnings and reminders are communicated to the end user through status information. This information can be integrated into any Asset Management System.

4.7.1 Time since Last Service: Time elapsed since last service. Can be reset to zero after performing a service. Can be reset locally by entering 0 into this parameter.

4.7.2 Time until Next Service: Read only. Service interval (4.7.6) less Time since Last Service (4.7.1)

4.7.3 Reminder 1 (Required): If Time Until Next Service (4.7.2) is equal or less than this value, the device generates a Maintenance required reminder.

Value Range: 0 to 20 years; Default 0.164 years

4.7.4 Reminder 2 (Demanded): If Time Until Next Service (4.7.2) is equal or less than this value, the device generates a Maintenance required reminder.

Value Range: 0 to 20 years; Default 0.019 years

4.7.5 Reminder Activation: Allows you to enable a maintenance reminder

Timer OFF - Default

ON NO LIMITS

ON Reminder 1 (Maintenance Required) checked

ON Reminders 1 and 2 checked

ON Reminder 2 (Maintenance Demanded) checked

4.7.6 Service Interval: User-configurable recommended time between product inspections.

Value Range: 0 to 20 years; Default 1.0 years

4.7.7 Maintenance Status: Indicates which level of maintenance reminder is active.

4.7.8 Acknowledge Status: Indicates which level of maintenance reminder has been acknowledged.

4.7.9 Acknowledge: Acknowledges the current maintenance reminder.

1. Press RIGHT arrow key twice to open parameter view and activate EDIT mode

2. Press RIGHT arrow key to acknowledge the reminder

4.8 Calibration Schedule: This device tracks calibration intervals on operating hours and monitors the predicted lifetime to the next calibration. You can modify the Total Calibration Interval, set schedules for maintenance reminders, and acknowledge them.

4.8.1 Time since Last Calibration: Time elapsed since last calibration. Can be reset to zero after performing a service.

Can be reset locally by entering 0 into this parameter.

4.8.2 Time until Next Calibration: Read only. Calibration interval (4.8.6) less Time since Last Calibration (4.8.1)

4.8.3 Reminder 1 (Required): If Time Until Next Calibration (4.8.2) is equal or less than this value, the device generates a Maintenance required reminder.

Value Range: 0 to 20 years; Default 0.164 years

4.8.4 Reminder 2 (Demanded): If Time Until Next Calibration (4.8.2) is equal or less than this value, the device ... generates a Maintenance required reminder.

Value Range: 0 to 20 years; Default 0.019 years

4.8.5 Reminder Activation: Allows you to enable a maintenance reminder

Timer OFF - Default

ON NO LIMITS

ON Reminder 1 (Maintenance Required) checked

ON Reminders 1 and 2 checked

ON Reminder 2 (Maintenance Demanded) checked

4.8.6 Service Interval: User-configurable recommended time between product calibrations.

Value Range: 0 to 20 years; Default 1.0 years

4.8.7 Maintenance Status: Indicates which level of maintenance reminder is active.

4.8.8 Acknowledge Status: Indicates which level of maintenance reminder has been acknowledged.

4.8.9 Acknowledge: Acknowledges the current maintenance reminder.

1. Press RIGHT arrow key twice to open parameter view and activate EDIT mode

2. Press RIGHT arrow key to acknowledge the reminder

5. Communication

5.1 Device Address: Sets the device address of poll ID on a HART network. Any address other than 0 will cause the output current to be a fixed value, and the current will not indicate the reading. Range should be limited to 0 to 15 for a HART 5 master.

Range: 0 to 63; Default 0

5.2 Remote Lock: Enables/disables the read/write access to parameters via remote communications.

ON: No Changes are permitted via remote communications

OFF: Changes are permitted

6. Security

6.1 Write Protection: Prevents any changes to parameters.

Range 0 to 9999

Unlock value (2457) > Lock OFF

Any other value > Lock ON

7. Language

Selects the language to be used on the LCD. Options include:

- ENGLISH (Default)
- GERMAN
- FRENCH
- SPANISH
- CHINESE

VII. MAINTENANCE

MP SERIES air radar requires no maintenance or cleaning under normal operating conditions.

Under severe operating conditions, the antenna may require periodic cleaning. If cleaning becomes necessary:

- Note the antenna material and the process medium, and select a cleaning solution that will not react adversely with either.
- Remove the instrument from service and wipe the antenna clean using a cloth and suitable cleaning solution.

UNIT REPAIR AND EXCLUDED LIABILITY

All changes and repairs must be done by qualified personnel, and applicable safety regulations must be followed. Please note the following:

- The user is responsible for all changes and repairs made to the device.
- All new components must be provided by Bindicator.
- Restrict repair to faulty components only.
- Do not re-use faulty components.

VIII. TROUBLESHOOTING

COMMUNICATION TROUBLESHOOTING

1. Check to see if there is power at the instrument and the LCD shows the relevant data
2. Verify that the wiring connections are correct.



















DEVICE STATUS ICONS

Icon	Priority Level	Meaning
	1	<ul style="list-style-type: none"> • Maintenance alarm • Measurement values are not valid
	2	<ul style="list-style-type: none"> • Maintenance warning: maintenance demanded immediately • Measured signal still valid
	3	<ul style="list-style-type: none"> • Maintenance required • Measured signal still valid
	1	<ul style="list-style-type: none"> • Process value has reached an alarm limit
	2	<ul style="list-style-type: none"> • Process value has reached a warning limit
	3	<ul style="list-style-type: none"> • Process value has reached a tolerance limit
	1	<ul style="list-style-type: none"> • Configuration error • Device will not work because one or more parameters/components is incorrectly configured
	2	<ul style="list-style-type: none"> • Configuration warning • Device can work but one or more parameters/components is incorrectly configured
	3	<ul style="list-style-type: none"> • Configuration changed • Device parameterization not consistent with parameterization in project. Look for info text.
	1	<ul style="list-style-type: none"> • Manual operation (local override) • Communication is good; device is in manual mode
	2	<ul style="list-style-type: none"> • Simulation or substitution value • Communication is good; device is in simulation mode or works with substitute values
	3	<ul style="list-style-type: none"> • Out of operation • Communication is good; device is out of action
		<ul style="list-style-type: none"> • Data exchanged
		<ul style="list-style-type: none"> • No Data exchanged
		<ul style="list-style-type: none"> • Write access enabled
		<ul style="list-style-type: none"> • Write access disabled

GENERAL FAULT CODES





- If more than one fault is present, the device status indicator and text for each fault alternate at 2 second intervals.
- If you receive an LOE error communicated via the communications bus, double-check with the device LUI prior to contacting the service department. Occasionally the device will show a hardware fault (S96) that is reported through the bus as an LOE. In such a case, the device electronics will need to be replaced.

Code/Icon	Meaning	Corrective Action
S:0 	The device was unable to get a measurement within the Fail-Safe LOE Timer period. Possible causes: faulty installation, antenna material buildup, foaming/other adverse process conditions, invalid calibration range.	<ul style="list-style-type: none"> • Ensure installation details are correct. • Ensure no material buildup. Clean if necessary. • Adjust process conditions to minimize foam or other adverse conditions. • Correct range calibration. • If fault persists, contact your local Bindicator representative.
S:2 	Unable to collect profile because of a power condition that is outside the operating range of the device.	<ul style="list-style-type: none"> • Repair required. Contact your local Bindicator representative.
S:3 	Device is nearing its lifetime limit according to the value set in Maintenance Demanded Limit.	<ul style="list-style-type: none"> • Replacement is recommended.
S:4 	Device is nearing its lifetime limit according to the value set in Maintenance Demanded Limit.	<ul style="list-style-type: none"> • Replacement is recommended.
S:6 	Sensor is nearing its lifetime limit according to the value set in Maintenance Demanded Limit.	<ul style="list-style-type: none"> • Replacement is recommended.
S:7 	Sensor is nearing its lifetime limit according to the value set in Maintenance Demanded Limit.	<ul style="list-style-type: none"> • Replacement is recommended.
S:8 	Service interval as defined in Maintenance Required Limit has expired.	<ul style="list-style-type: none"> • Perform service.
S:9 	Service interval as defined in Maintenance Required Limit has expired.	<ul style="list-style-type: none"> • Perform service.
S:11 	Internal temperature sensor failure	<ul style="list-style-type: none"> • Repair required; contact Bindicator
S:12 	Internal temperature of device has exceeded specifications: it is operating out-side its temperature range.	<ul style="list-style-type: none"> • Relocate device and/or lower process temperature enough to cool device. • Inspect for heat-related damage and contact Bindicator if repair is required. • Fault code will persist until a manual reset is performed using SIMATIC PDM or the LCD interface.

Code/Icon	Meaning	Corrective Action
S:17 	Calibration interval as defined in Maintenance Required Limit has expired.	<ul style="list-style-type: none"> Perform calibration
S:18 	Calibration interval as defined in Maintenance Demanded Limit has expired.	<ul style="list-style-type: none"> Perform calibration
S:25 	Internal error	<ul style="list-style-type: none"> Reset power. If fault persists, contact Bindicator
S:27 	Internal device failure caused by an External RAM memory error.	<ul style="list-style-type: none"> Repair required, contact Bindicator
S:28 	Internal device failure caused by a RAM memory error.	<ul style="list-style-type: none"> Repair required, contact Bindicator
S:29 	EEPROM damaged	<ul style="list-style-type: none"> Repair required, contact Bindicator
S:30 	EEPROM corrupt	<ul style="list-style-type: none"> Reset power. If fault persists, contact Bindicator
S:31 	Flash error	<ul style="list-style-type: none"> Repair required, contact Bindicator
S:33 	Factory calibration for the internal temperature sensor has been lost.	<ul style="list-style-type: none"> Repair required: contact Bindicator.
S:34 	Factory calibration for the device has been lost.	<ul style="list-style-type: none"> Repair required: contact Bindicator.
S:48 	User configuration is invalid. One or more of parameters: Low Calibration Point, High Calibration Point, Volume breakpoints, and/or Auto False-Echo Suppression, are set to invalid values.	<ul style="list-style-type: none"> Reconfigure the unit. Ensure the difference between High Calibration Point and Low Calibration Point is not less than or equal to zero; do a Master Reset.
S:52 	Fail-Safe is activated. Possible causes: 1. hardware failure 2. memory failure 3. Fail-safe LOE timer expired-possible causes: faulty installation, antenna material build-up, foaming/other adverse process conditions, invalid calibration range	<ul style="list-style-type: none"> For 1 and 2: if fault persists, contact Bindicator For 3: <ul style="list-style-type: none"> Correct configuration; ensure installation is correct No antenna build-up Adjust process conditions to minimize adverse conditions Correct calibration range
S:54 	Fault occurs when the PV exceeds the user configured min./max. range for mA output.	<ul style="list-style-type: none"> Adjust process to fall within limits of min./max. mA values or adjust limits of mA if possible.
S:66 to S:83 	Device error. NOTE fault text and icons appear only on LCD	<ul style="list-style-type: none"> Repair required, contact Bindicator
S:94 	Device error. Possible causes: 1. Voltage too low 2. Hardware defect	<ul style="list-style-type: none"> For 1: Confirm voltage is within specifications and modify wiring or increase source voltage accordingly For 2: Require required, contact Bindicator
S:95 to 97 	Device error. NOTE fault text and icons appear only on LCD	<ul style="list-style-type: none"> Repair required, contact Bindicator
S:98 to 108 	Device error. NOTE fault text and icons appear only on LCD	<ul style="list-style-type: none"> Repair required, contact Bindicator
S:109 to 112 	Device error. NOTE fault text and icons appear only on LCD	<ul style="list-style-type: none"> Repair required, contact Bindicator

OPERATION TROUBLESHOOTING

Operating symptoms, probable causes, and resolutions.

Display/Symptom	Cause	Action
S:0 LOE 	Level or target is out of range	<ul style="list-style-type: none"> check specifications check Low Calibration Point (2.3.5.1.)
S: 0 LOE 	Material build-up on antenna	<ul style="list-style-type: none"> use the air purge feature to clean the antenna re-locate unit
S: 0 LOE 	Location or aiming: <ul style="list-style-type: none"> poor installation flange not level Auto False Echo Suppression may be incorrectly applied 	<ul style="list-style-type: none"> check to ensure nozzle/standpipe is vertical ensure the nozzle is not protruding into antenna area review Auto False Echo Suppression (2.4.8.1.) ensure Auto Suppression Range is set correctly
S: 0 LOE 	Antenna malfunction: <ul style="list-style-type: none"> temperature too high physical damage 	<ul style="list-style-type: none"> check temperature in Maximum Value (3.4.2.) relocate unit
Reading does not change, but the level does	Unit processing wrong echo, i.e. vessel wall, or structural member	<ul style="list-style-type: none"> re-locate unit check nozzle for internal burrs or welds use Auto False Echo Suppression (2.4.8.1.) if necessary: see Auto False Echo Suppression (2.4.8.1.)
Measurement is consistently off by a constant amount	<ul style="list-style-type: none"> setting for Low Calibration Point (2.3.5.1) not correct setting for Sensor Offset (2.3.5.3.) not correct 	<ul style="list-style-type: none"> check distance from sensor reference point to Low Calibration Point (2.3.5.1.) check Sensor Offset (2.3.5.3.)
Screen blank	Power error	<ul style="list-style-type: none"> check nameplate rating against voltage supply check power wiring or source
Reading erratic	Echo confidence weak	<ul style="list-style-type: none"> refer to Confidence (2.4.7.1.) use Auto False Echo Suppression (2.4.8.1.) and Auto False EchoSuppression Range (2.4.8.2.) use foam deflector or stillpipe
	Material filling	<ul style="list-style-type: none"> relocate unit
Reading response slow	Fill Rate/Min (2.3.6.2.) setting is incorrect	<ul style="list-style-type: none"> increase measurement response if possible
Reads correctly but occasionally reads high when vessel is not full	<ul style="list-style-type: none"> detecting close range echo build up near top of vessel or nozzle nozzle problem 	<ul style="list-style-type: none"> use the air purge feature to clean the antenna use Auto False Echo Suppression (2.4.8.1.) and Auto False Echo Suppression Range (2.4.8.2.)

Display/Symptom	Cause	Action
Level reading lower than material level	<ul style="list-style-type: none"> • material is within Near Range zone • multiple echoes processed 	<ul style="list-style-type: none"> • decrease Near Range (2.4.1.): minimum value depends on model • raise unit • ensure Algorithm (2.4.5.1.) is set to tF (trueFirst echo)
	<ul style="list-style-type: none"> • vessel near empty and low dK material 	<ul style="list-style-type: none"> • set Position Detect (2.4.5.2.) to Hybrid • check the setting for CLEF Range (2.4.5.4.)

MENU

1. WIZARDS

1.1 QUICK START WIZ

- VESSEL
- RESPONSE RATE
- UNITS
- LOW CALIB. PT
- HIGH CALIB. PT

1.2 AFES WIZ

1.3 CPY PARA TO DISPLAY

1.4 CPY PARA FROM DISPLAY

1.5 CPY FIRMWARE TO DISPLAY

1.6 CPY FIRMWARE FROM DISPLAY

2. SETUP

2.1 DEVICE

- 2.1.1 LONG TAG
- 2.1.2 TAG
- 2.1.3 DESCRIPTOR
- 2.1.4 MESSAGE
- 2.1.5 INSTAL DATE
- 2.1.6 HARDWARE REV
- 2.1.7 FIRMWARE REV
- 2.1.8 LOADER REV
- 2.1.9 MANUF. DATE

2.2 SENSOR

- 2.2.1 UNITS
- 2.2.2 SENSOR MODE
- 2.2.3 DAMPING FILTER
- 2.2.4 TEMP UNITS
- 2.2.5 UNIT

2.3 CALIBRATION

- 2.3.1 LOW CALIB PT
- 2.3.2 HIGH CALIB PT
- 2.3.3 SENSOR OFFSET

2.4 RATE

- 2.4.1 RESPONSE RATE
- 2.4.2 FILL RATE/MIN
- 2.4.3 EMPTY RATE/MIN

2. SETUP CONT...

2.5 FAIL-SAFE

- 2.5.1 MAT. LEVEL
- 2.5.2 TIMER
- 2.5.3 LEVEL

2.6 ANALOG OUTPUT SCALE

- 2.6.1 CURRENT OUTPUT FNT
- 2.6.2 4MA SETPOINT
- 2.6.3 20MA SETPOINT
- 2.6.4 MIN MA LIMIT
- 2.6.5 MAX MA LIMIT
- 2.6.6 MA OUTPUT MODE
- 2.6.7 MANUAL VALUE
- 2.6.8 MA OUTPUT VALUE

2.7 SIGNAL PROCESSING

- 2.7.1 NEAR RANGE
- 2.7.2 FAR RANGE
- 2.7.3 ECHO SELECT
 - 2.7.3.1 ALGORITHM
 - 2.7.3.2 ECHO THRESHOLD
 - 2.7.3.3 POSITION DETECT
 - 2.7.3.4 CLEF RANGE
 - 2.7.3.5 ECHO MARKER
- 2.7.4 SAMPLING
 - 2.7.4.1 ECHO LOCK
 - 2.7.4.2 UP SAMP.
 - 2.7.4.3 DOWN SAMP.
 - 2.7.4.4 ECHO LK WINDOW
- 2.7.5 FILTERING
 - 2.7.5.1 NRW ECHO FILTER
 - 2.7.5.2 REFORM ECHO
 - 2.7.5.3 AVG AMOUNT
- 2.7.6 ECHO QUALITY
 - 2.7.6.1 CONFIDENCE
 - 2.7.6.2 ECHO STRENGTH

2. SETUP CONT...

2.8 TVT SET UP

- 2.8.1 AUTO ECHO SUPP
- 2.8.2 AUTO SUPP RANGE
- 2.8.3 HOVER LEVEL
- 2.8.4 SHAPER MODE

2.9 TVT SHAPER

- 2.9.1 BRKPT 1-9
- 2.9.2 BRKPT 10-18
- 2.9.3 BRKPT 19-27
- 2.9.4 BRKPT 28-36
- 2.9.5 BRKPT 37-45
- 2.9.6 BRKPT 46-54
- 2.9.7 BRKPT 55-63
- 2.9.8 BRKPT 64-72
- 2.9.9 BRKPT 73-81
- 2.9.10 BRKPT. 82-90
- 2.9.11 BRKPT. 91-99
- 2.9.12 BRKPT. 100-108
- 2.9.13 BRKPT. 109-117
- 2.9.14 BRKPT. 118-120

2.10 MEASURED VALUES

- 2.10.1 MAIN OUTPUT
- 2.10.2 O/P NO LINEAR
 - 2.10.2.1 O/P NO OFFSET

3. DIAGNOSTICS

- 3.1 FAULT RESET
- 3.2 ECHO PROFILE
- 3.3 TREND
- 3.4 PEAK VALUES
 - 3.4.1 MIN MEAS VALUE
 - 3.4.2 MAX MEAS VALUE
 - 3.4.3 MINIMUM PV
 - 3.4.4 MAXIMUM PV
 - 3.4.5 MINIMUM SV
 - 3.4.6 MAXIMUM SV

3. DIAGNOSTICS CONT...

3.5 ELECT TEMP

3.5.1 MIN VALUE

3.5.2 MAX VALUE

3.5.3 INTERN TEMP

3.6 REMAIN DEV LIFE

3.6.1 TIME IN OPER

3.6.2 REMAIN LIFETIME

3.6.3 REMIND 1 (REQ)

3.6.4 REMIND 2 (DEM)

3.6.5 REMINDER ACTIVATION

3.6.6 LIFETIME EXPECTED

3.6.7 MAINT STAT

3.6.8 ACK STATUS

3.6.9 ACK

3.7 REMAIN SENS LIFE

3.7.1 TIME IN OPER

3.7.2 REMAIN LIFETIME

3.7.3 REMIND 1 (REQ)

3.7.4 REMIND 2 (DEM)

3.7.5 REMINDER ACTIVATION

3.7.6 LIFETIME EXPTECTED

3.7.7 MAINT STAT

3.7.8 ACK STATUS

3.7.9 ACK

4. SERVICE

4.1 DEMO MODE

4.2 MASTER RESET

4.3 POWERED HOURS

4.4 POWERON RESETS

4.5 LCD BACKLIGHT

4.6 LCD CONTRAST

4.7 SERVICE SCHEDULE

4.7.1 TIME LAST SERVICED

4.7.2 TIME NEXT SERVICE

4.7.3 REMIND. 1 (REQ.)

4.7.4 REMIND. 2 (DEM.).

4.7.5 REMIND. ACTIVATION

4.7.6 SERVICE INTERVAL

4.7.7 MAINT STAT

4.7.8 ACK STATUS

4.7.9 ACK

4.8 CALIB. SCHED.

4.8.1 TIME LAST CALIB

4.8.2 TIME NEXT CALIB

4.8.3 REMIND. 1 (REQ.)

4.8.4 REMIND. 2 (DEM.)

4.8.5 REMINDER ACTIV.

4.8.6 MAINT STATUS

4.8.7 ACK STATUS

4.8.8 ACK

4.9 STORED SW VER

5. COMMUNICATION

5.1 DEVICE ADDRESS

5.2 REMOTE LOKOUT

6. SECURITY

6.1 WRITE PROTECTION

7. LANGUAGE

NOTES

NOTES



150 Venture Boulevard
Spartanburg, SC 29306
Tel: (800) 778-9242
Fax: (864) 574-8063
sales@bindicator.com
www.bindicator.com

venture
MEASUREMENT

2016 All rights reserved.
All data subject to change without notice.

MPR180416 Rev. B