



Model SONO-1000 Installation & Operation Manual





Model SONO-1000 Installation & Operation Manual

CONTENTS

I. HANDLING & STORAGE	1
Inspection and Handling	
Disposal and Recycling	
Storage	
II. GENERAL SAFETY	2
Authorized Personnel	
Use	
Misuse	
III. PRODUCT DESCRIPTION	3
Function	
Applications	
Technical Specifications	
IV. MECHANICAL INSTALLATION	5
Guidelines	
Mounting Considerations	
Positioning	
Figure 1: Sun Protection	
Figure 2: Mounting Positions	
Mounting	
Figure 3: Mounting	
Aiming the SONO-1000	
V. ELECTRICAL INSTALLATION	8
General Safety	
Disconnect Requirements for Permanently Installed Equipment	
Conduit Cable Connection	
Electrical Connections	
Figure 4: Wiring Diagram	
VI. SETUP	10
Measurement Configuration	
Current Output	
Relay Output	
Measurement Optimization	
Volume Calculation	
Volume Flow Measuring	
32-Point Linearization Curve	
Informational Parameters	
Simulation Mode	

Access Lock
Parameter Table

VII. MAINTENANCE 32
 Preventative Maintenance

VIII. TROUBLESHOOTING 32

IX. DIMENSIONAL DRAWINGS 33

X. WARRANTY 34

SAFETY SYMBOLS



WARNING:

IDENTIFIES CONDITIONS OR PROCEDURES, WHICH IF NOT FOLLOWED, COULD RESULT IN SERIOUS INJURY. RISK OF ELECTRICAL SHOCK.



CAUTION:

IDENTIFIES CONDITIONS OR PROCEDURES, WHICH IF NOT FOLLOWED, COULD RESULT IN SERIOUS DAMAGE OR FAILURE OF THE EQUIPMENT.

MODEL SONO-1000

I. HANDLING AND STORAGE

SAVE THESE INSTRUCTIONS

INSPECTION AND HANDLING

Do not dispose of the carton or packing materials.

Each package should be inspected upon receipt for damage that may have occurred due to mishandling during shipping. If the unit is received damaged, notify the carrier or the factory for instructions. Failure to do so may void your warranty. If you have any problems or questions, consult Bindicator® Customer Support at 1-800-778-9242.

DISPOSAL AND RECYCLING

This product can be recycled by specialized companies and must not be disposed of in a municipal collection site. If you do not have the means to dispose of properly, please contact Bindicator for return and disposal instructions or options.

STORAGE

If the device is not scheduled for immediate installation following delivery, the following steps should be observed:

1. Following inspection, repackage the unit into its original packaging.
2. Select a clean dry site, free of vibration, shock and impact hazards.
3. If storage will be extended longer than 30 days, the unit must be stored at temperatures between 32° and 158° F (0° to 70° C) in non-condensing atmosphere with humidity less than 98%



CAUTION: DO NOT STORE A NON-POWERED UNIT OUTDOORS FOR A PROLONGED PERIOD.

II. GENERAL SAFETY

AUTHORIZED PERSONNEL

All instructions described in the document must be performed by authorized and qualified service personnel only. Before installing the unit, please read these instructions and familiarize yourself with the requirements and functions of the device. The required personal protective equipment must always be worn when servicing this device.

USE

The device is solely intended for use as described in this manual. Reliable operation is ensured only if the instrument is used according to the specifications described in this document. For safety and warranty reasons, use of accessory equipment not recommended by the manufacturer or modification of this device is explicitly forbidden. All servicing of this equipment must be performed by qualified service personnel only. This device should be mounted in locations where it will not be subject to tampering by unauthorized personnel.

MISUSE

Improper use or installation of this device may cause the following:

- Personal injury or harm
- Application specific hazards such as vessel overfill
- Damage to the device or system

If any questions or problems arise during installation of this equipment, please contact the manufacturer Customer Support at 800-778-9242.

III. PRODUCT DESCRIPTION

FUNCTION

The ultrasonic level metering technology is based on the principle of measuring the time required for the ultrasound pulses to make a round trip from the sensor to the level to be measured and back. The sensor emits an ultrasonic pulse train and receives the echoes reflected. The intelligent electronic device processes the received signal by selecting the echo reflected by the surface and calculates from the time of flight the distance between the sensor and the surface which constitutes the basis of all output signals of the single tank ultrasonic sensor.

A total beam angle of 5° at -3 dB is a unique feature of this single tank ultrasonic sensor designed for the level measurement of free flowing solids. This uniquely narrow beam angle ensures reliable measurement in narrow silos with uneven side walls or sometimes even in the presence of dusting. The narrow beam angle allows the emitted ultrasonic signals to have an outstanding focusing and allow a sufficient signal to penetrate through dust.

Minimum measuring distance 2 ft (0.6 m): (also known as the “Dead Band”) is a feature common to all ultrasonic level meters. This is a short range in front of the sensor within which the ultrasonic device cannot measure.

Maximum measuring distance 98 ft (30 m): The longest range under ideal condition within which the device can measure. No measurement is possible beyond this distance.

Diameters corresponding to 5° beam angle.

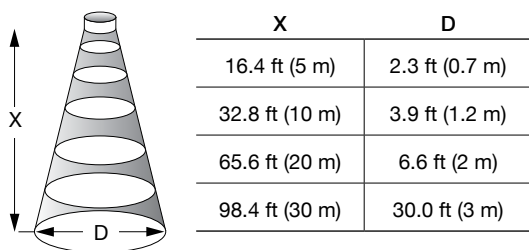

APPLICATIONS

The SONO-1000 is a compact ultrasonic transmitter designed to measure the level of the free flowing solids such as powders and granules. This intelligent microprocessor based, smart, level transmitter offers scaleable 4-20 mA output, and programmable relay. Level measurement technology based on the non-contacting ultrasonic principle is especially suited for applications where, for any reason, no physical contact can be established to the surface of the material or where non-contact with the material is desired.

TECHNICAL SPECIFICATIONS

FUNCTIONAL	Model U1-33-A	Model U1-33-D
Power Requirements	85 to 255 VAC	11.4 to 40 VDC and 11.4 to 28 VAC
Power Consumption	(50/60 Hz) / 6.8 VA	4.1 W, 11.4 to 28 V AC (50/60 Hz) / 4.6 VA
Operating Temperature Electronics	-22° to 140° F (-30° to 60° C)	
Outputs	SPDT, 250 V AC / 3 A, non-inductive	
PERFORMANCE		
Maximum Measuring Range	98 ft (30 m)	
Minimum Measuring Range	2 ft (0.6 m)	
Beam Angle	5°	
Pressure Rating	0.7 to 1.1 bar	
Frequency	30 kHz	
Accuracy	± 0.2% of the measured distance plus 0.05% of range	
PHYSICAL		
Enclosure Material, Rating	Powder paint coated aluminium, IP67	
Conduit Entries	(2) ½" NPT; (2) M20 x 1.5	
Process Connection	6" (280 mm) or 8" (343 mm) flange	
Mounting Plate Material	Polypropylene (PP)	
Shipping Weight	15.4 lb (7 kg)	

IV. MECHANICAL INSTALLATION



WARNING: VERY HIGH VOLTAGE IS PRESENT.

REMOVE POWER FROM THE UNIT BEFORE INSTALLING, REMOVING, OR MAKING ADJUSTMENTS

GUIDELINES

The following precautions should be observed when installing and operating the product:

- The installation and wiring of this product must comply with all national, federal, state, municipal and local codes that apply.
- This product is a precision device - handle the device with great care, especially the sensing probe.
- Any impact on the sensing probe may ruin its resonance system.
- A protective shield should be installed if probe is exposed to falling material or excessive mechanical load.



CAUTION: ATTEMPTING TO TIGHTEN THE SONO-1000 BY ROTATING THE HOUSING OR ROD MAY DAMAGE THE UNIT AND VOID THE WARRANTY.

MOUNTING CONSIDERATIONS

POSITIONING

Selecting optimal location for the transmitter; various considerations should be made.

If the measured material is granule (material size > 5 mm) and the tank roof is dome shaped or conical, do not install the transmitter in the center of the tank/silo. In general the transmitter can be installed at $\frac{1}{3}$ the radius of the vessel.

Avoid that the 5° conical beam angle of the transmitter contact the tank/silo wall. In case the transmitter is mounted close to the wall, it should be tilted. Protect the transmitter electronics from overheating due to direct sunshine.

FIGURE 1: Sun Protection

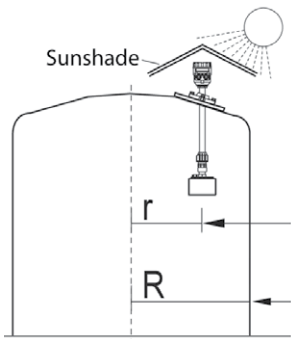
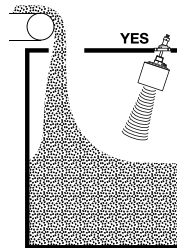
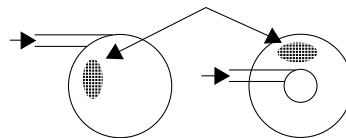

FIGURE 2: Mounting Positions



Gravity Filling:
Select a location as far away from filling point(s) as possible.



Pneumatic Filling:
Select a location where the speed of in-flowing material is smallest.

MOUNTING

The SONO-1000 consists of a sensor that is attached to the aiming arm (a pipe with a ball-joint housing incorporating a ball joint) that is attached to the housing of the electronics. It is recommended to mount the transmitter on the roof of the tank/silo using a flange. The ball-joint housing has a screw-hole diameter of 4.9 in (125 mm) for fixing it. For easy installation we recommend using a flange with a split insertion. Removing the split insertion, the flange is to be put around the aiming arm and the ball-joint housing is to be fixed to the split flange. It is essential to use the washers and the bolts (4 pcs each) delivered with the split flange. The ball-joint will be pressed to the housing by a spring allowing adjustment/aiming. The 4 pcs of M12 bolts need tightened after completing the adjustment/aiming.

1. Check the split flange for matching the bore-holes with that of the counter-flange on the silo
2. Remove the split insertion from the flange and put the flange around the aiming arm between the sensor and the base.
3. Slide the split insertion back to its place and screw the ball-joint housing to the flange with the 4 pcs M 12 bolts to such an extent that will allow free movement of the aiming arm through and tilting by the ball joint for the aiming process.
4. Pass the sensor through the opening cut on the roof and fasten the flange to its place.
5. Perform the aiming.
6. For fixing the position of the aiming arm tighten the 4 pcs M 12 bolts of the ball-joint housing (Max. 31 in/lbs, 3.5 Nm).

If the entire tilting range of the aiming arm is required, the thickness of the roof cannot exceed a thickness as specified in Figure 3.

The SONO-1000 can also be mounted on existing (manhole) covers, access lids or for instance on a steel structure lowered into a larger opening on the roof, e.g. 1.6 x 1.6 ft (0.5 x 0.5 m). This solution should be used with roofs thicker than 13.8 to 15 in (350 to 380 mm).

FIGURE 3: Mounting

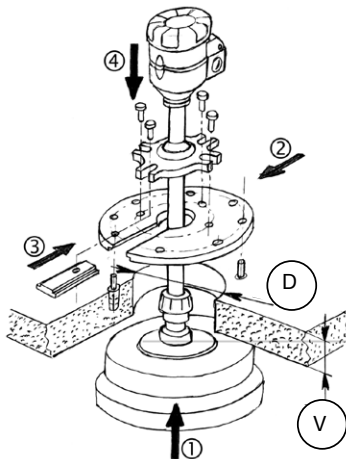

RECOMMENDED DIAMETER OPENING, GIVEN ROOF THICKNESS

Diameter of Opening (D)	Thickness of Roof (V)
6.3 in (160 mm)	4.3 in (110 mm)
7.5 in (190 mm)	5.9 in (150 mm)
9.1 in (230 mm)	7.9 in (200 mm)
11.8 in (300 mm)	11.0 in (280 mm)
13.4 in (340 mm)	11.8 in (300 mm)

AIMING THE SONO-1000

To reduce weak signal reflection from the material surface caused by an angle of repose building due to the filling and/or emptying process, it is recommended to tilt the sensor by the aiming arm of the transmitter. Aiming is best carried out during operation, when the tank/silo is almost empty. In most cases, the sensor should be aimed towards the middle of the tank/silo bottom by aiming at the silo outlet. In applications where repose is not present or with tall and narrow silos (diameter/height ≥ 5) aiming is not critical: the sensor should face straight downwards.

Aiming should also be tested with full silo, since due to the great angle of repose the echo might be weak despite of the fact that level is near to the sensor. In such cases a reasonable compromise of aiming should be achieved that provide acceptable echo in every state of the filling.

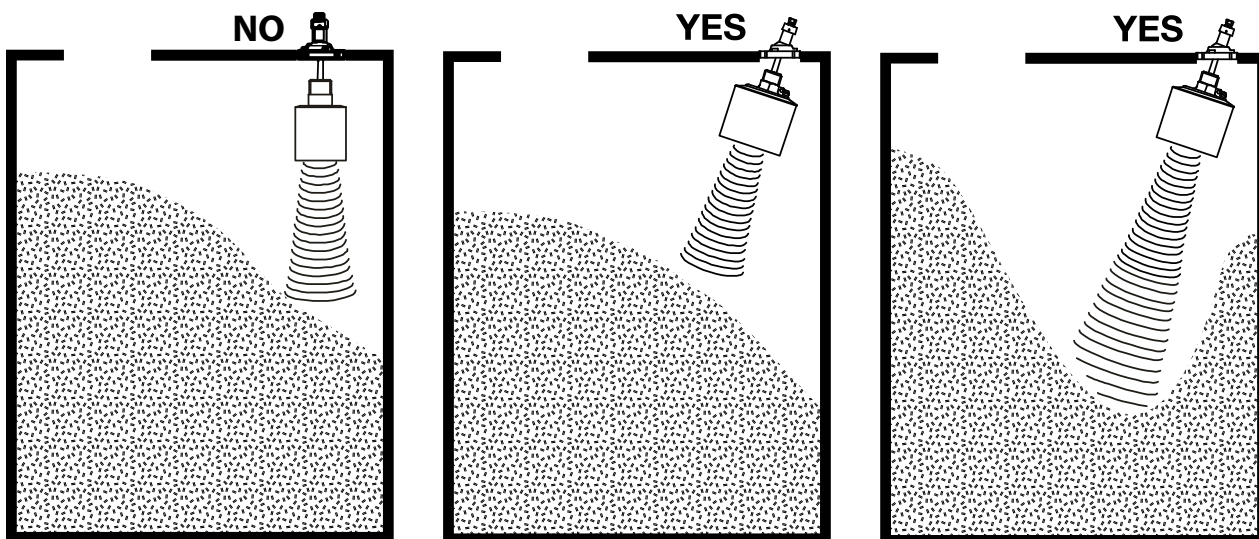

V. ELECTRICAL INSTALLATION



**WARNING: VERY HIGH VOLTAGE IS PRESENT.
REMOVE POWER FROM THE UNIT BEFORE INSTALLING, REMOVING, OR MAKING ADJUSTMENTS.**

GENERAL SAFETY

When using electrical equipment, you should always follow basic safety precautions, including the following:

- The installation and wiring of this product must comply with all national, federal, state, municipal, and local codes that apply.
- Do not modify any factory wiring. Connections should only be made to the terminals described in this section.

DISCONNECT REQUIREMENTS FOR PERMANENTLY INSTALLED EQUIPMENT

A dedicated disconnecting device (circuit breaker) must be provided for the proper installation of the unit. If independent circuits are used for power input and main relay outputs, individual disconnects are required.

Disconnects must meet the following requirements:

- Located in close proximity to the device
- Easily accessible to the operator
- Appropriately marked as the disconnect for the device and associated circuit
- Sized appropriately to the requirements of the protected circuit (See specifications)

CONDUIT-CABLE CONNECTION

Two threaded $\frac{1}{2}$ " NPT and two M20 x 1.5 female conduit openings are provided in the housing for input and output wiring. When only one conduit opening is used for installation, the unused opening must be sealed with a suitable type plug with pipe sealant in order to maintain approval requirements.

ELECTRICAL CONNECTIONS

- To access the electric connection point, unscrew the bolt on the side of the electronics housing.
- Route all AC wiring separately from all other wiring.
- Devices must be grounded to earth ground either at the internal or external grounding screw terminals depending on the way of cabling.
- This unit is a 4-wire device therefore, loop power is not required, and the receiving device should be set-up as sinking/passive.
- DC powered devices can be 3-wire connected. In this case the terminals "1" and "6" must be interconnected. In this case the galvanic isolation will not be provided.
- After performing the electric connections, check for correct sealing and close the housing.
- 4-20 mA cable should be Belden 8790 or equivalent; twisted, shielded pair, 18 AWG (1,020 mm diameter)

Figure 4: Wiring Diagram

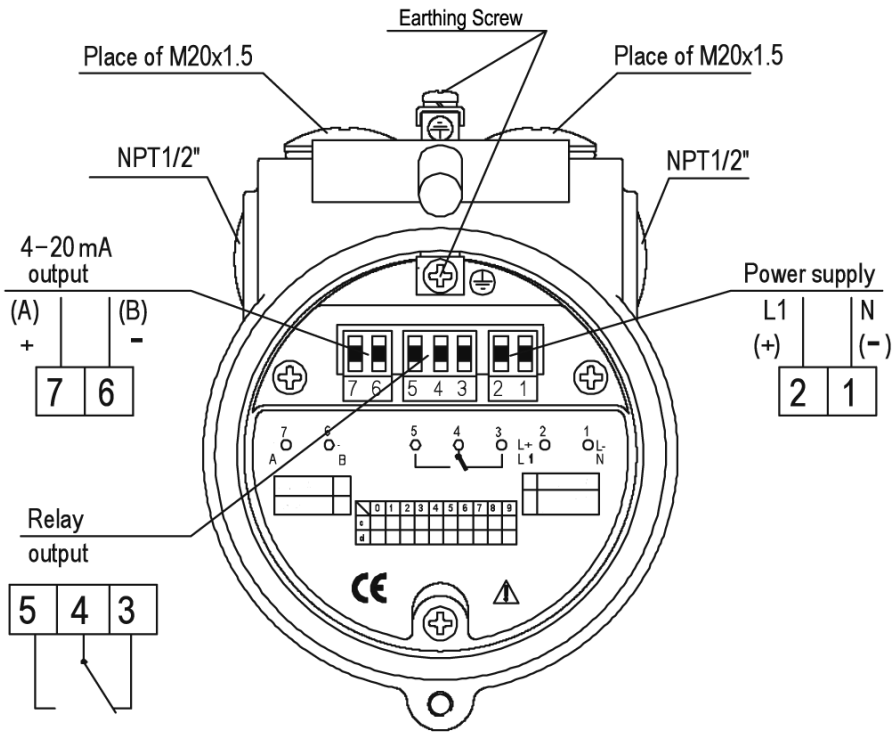

VI. SET-UP



WARNING: ELECTROSTATIC DISCHARGE CAUSED BY TOUCHING THE TERMINALS OF THE SAP-100 PROGRAMMING MODULE MAY CAUSE DAMAGE TO THE DEVICE. AVOID THIS BY COMMON MEANS OF PREVENTING ELECTROSTATIC DISCHARGE (EX., BY TOUCHING A GROUNDED POINT BEFORE OPENING THE DEVICE.)

PROGRAMMING

Modification of the parameters (programming) is required to customize the transmitter to the actual parameters of the tank/silo.

Programming is performed by the indicator module SAP-100. The programming/indicator module can be plugged or unplugged even while the unit is powered up. The indicator module is accessed by removing the top cover. The SONO-1000 can work without the indicator.

CURRENT OUTPUT SCALING

Recommended as a simple and fast way to modify the scaling of the current output.

QUICKSET

Recommended as a simple and fast way to set up the SONO-1000 by 8 basic parameters. This menu driven programming mode supports the following basic settings:

- Engineering unit for the display (Metric or US)
- Maximum measuring distance
- Assignment of min level to 4 mA
- Assignment of max level to 20 mA
- Error indication by the current output
- Damping time
- Assignment of level to energizing of the relay
- Assignment of level to de-energizing of the relay

FULL PARAMETER ACCESS

All features of the SONO-1000 can be accessed by parameter addresses:

Example:

- Measurement configuration
- Outputs
- Measurement Optimization
- 6 pre-programmed tank shapes for volume calculation
- 32-point linearization table

Figure 5: Display and Keys

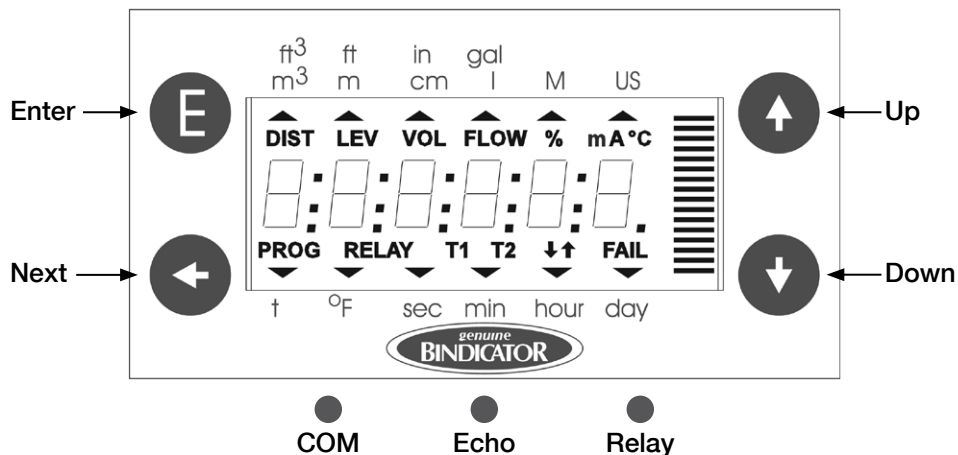

Symbols used on the LCD:

- DIST – Distance (measuring) mode
- LEV – Level (measuring) mode
- VOL – Volume (measuring) mode
- PROG – Programming mode (device under programming)
- RELAY – Relay
- FAIL – Measurement / device error
- – Level changing direction
- Bar graph assigned to the current output or echo strength

Symbols used on the frame:

- M – Metric system
- US – US calculation system

Programming will be performed by pressing one key, or two keys simultaneously.

SINGLE KEY PRESSING

- Press key ENTER – to save parameter address and go to parameter value to return from parameter value to parameter address
- Press NEXT to move the blinking of the digit to the left
- Press UP to increase value of the blinking digit
- Press DOWN to decrease value of the blinking digit

DOUBLE KEY PRESSING

Press the two keys simultaneously for desired programming step.

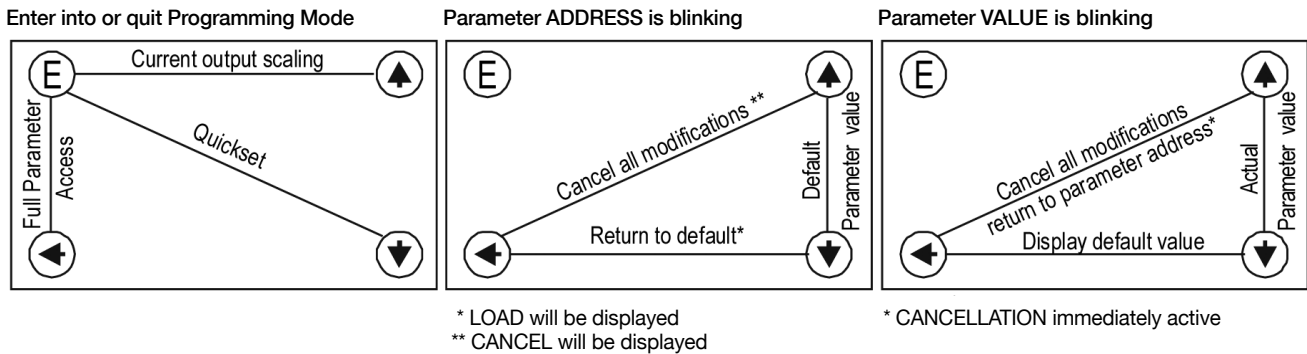

If the parameter value is not accessible, i.e. the parameter address keeps blinking after pressing ENTER

- the parameter is either a read-out type, or
- the secret code prevents the modification.

If the modification of the parameter value is not accepted i.e. the parameter value keeps blinking after pressing ENTER

- the modified value is either out of the range, or
- the code entered is not valid for this parameter

FIELD INDICATION

Depending on the measuring mode the following values can be displayed (relevant symbol is lit):

- Distance
- Level
- Volume
- Error code (if "FAIL" is blinking)

To scroll through the displays above press NEXT repeatedly.

To display transducer temperature, press UP

To display current output value, press DOWN

LED INDICATION

- ECHO - LED
LED is lit as long as the device receives a valid echo signal
- RELAY - LED
LED is lit when relay is energized
- COM - LED
LED is lit during communication (Remote control)

CURRENT OUTPUT SCALING

This programming mode is the simple and fast way to modify the scaling of the current output. For changing all parameters other than those assigned to 4 and 20 mA use either the Quickset or the Full Parameter Access.

Current Output Scaling mode is useful for re-scaling, i.e. for modifying of the minimum and maximum level assigned to the output signals 4 and 20 mA, if other than the factory default. Current Output Scaling is aided by 2 screens for setting. The instructions for this programming can also be found below the screw cover on the front panel of the SONO-1000.

Note: For this programming the SONO-1000 has to be in level measurement mode.

KEYS	FUNCTION
ENTER E + UP (press for 3 seconds)	Enter or exit Current Output Scaling programming mode
UP / DOWN	Increase/decrease blinking digit or scroll up/down
NEXT	Move left with the blinking digit
UP + DOWN	GET LEVEL - display actual level value measured by the Sono-1000
ENTER E	Save actual value on the screen and move to the next screen
NEXT + UP	Quit Current Output Scaling without saving the modifications
NEXT + DOWN	Display Factory Default of the relevant screen

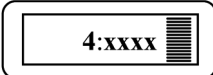
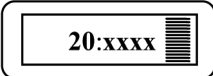
SCREENS	ACTIONS
<p>4 represents the output signal x = level value to be assigned</p> 	<p>4 mA xxxx: – level value assigned to 4 mA current output</p> <p>Manual: set required value (by UP / DOWN / NEXT keys) and save it (by the key ENTER E)</p> <p>Automatic: use the “GET LEVEL” function (UP + DOWN) to obtain actual measured value with level in tank or a fix target, e.g. wall. (“GET LEVEL” functions only if ECHO LED is lit) and save it as above.</p> <p>DEFAULT: 0 m (0%, Empty tank)</p>
<p>20 represents the output signal x = level value to be assigned</p> 	<p>20 mA xxxx: – Level value assigned to 20 mA current output</p> <p>Manual: set required value (by UP / DOWN / NEXT keys) and save it (by the key ENTER E)</p> <p>Automatic: use the “GET LEVEL” function (UP + DOWN) to obtain actual measured value with level in tank or a fix target, e.g. wall. (“GET LEVEL” functions only if ECHO LED is lit) and save it as above</p> <p>DEFAULT: max. level = max. measuring distance - dead band (100%, Full tank)</p>

QUICKSET

This is recommended as a simple and fast way to start up SONO-1000. Quickset programming is aided by eight screens to set the eight basic parameters of the device if the required application is uncomplicated level metering, recommended for liquids only.

The instructions of this programming mode are also to be found, below the screw cover, on the front panel of the SONO-1000. The default of the Current output, Display and Bar graph is ‘LEVEL’. This can be modified only in the Full Parameter Access mode.

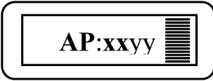
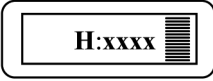
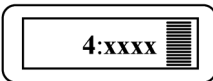
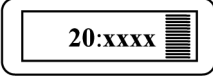
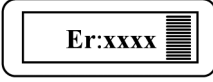
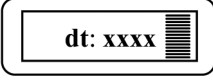
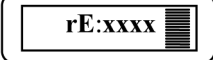
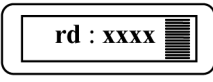
KEYS	FUNCTION
ENTER E + DOWN (press for 3 seconds)	Enter or exit Quickset programming mode
UP / DOWN	Increase/decrease blinking digit or scroll up/down
NEXT	Move left with the blinking digit
UP + DOWN	GET LEVEL - display actual level value measured by the Sono-1000
ENTER E	Save actual value on the screen and move to the next screen
NEXT + UP	Quit Current Output Scaling without saving the modifications
NEXT + DOWN	Display Factory Default of the relevant screen
	<p>AP plication</p> <p>xx = select "EU" (European) for metric or "US" for US engineering units (Use UP / DOWN keys)</p> <p>yy= indicating "Li" for liquids or "So" for solids level measurement (can not be changed).</p> <p>DEFAULT: EU</p>
	<p>H = xxxx maximum measuring distance – Distance between transducer face and tank/silo bottom</p> <p>Manual: set value (Use UP / DOWN / NEXT keys) and save it (by ENTER E)</p> <p>Automatic: use the "GET LEVEL" function (UP + DOWN) to obtain actual measured value with level in tank or a fix target, i.e. wall. ("GET LEVEL" functions only if ECHO LED is lit) and save it as above.</p> <p>DEFAULT: maximum measuring distance [m], see Technical Data Table</p>
	<p>4 mA xxxx – level value assigned to 4 mA current output</p> <p>Manual: set level value (by UP / DOWN / NEXT keys) and save it (by ENTER E)</p> <p>Automatic: use the "GET LEVEL" function (UP + DOWN) to display the actual measured value with level in tank or a fix target, i.e. wall. ("GET LEVEL" functions only if ECHO LED is lit) and save it as above.</p> <p>DEFAULT: 0 m (0%, Empty tank)</p>
	<p>20 mA xxxx – level value assigned to 20 mA current output</p> <p>Manual: set level value (Use UP / DOWN / NEXT keys) and save it (by ENTER E)</p> <p>Automatic: use the "GET LEVEL" function (UP + DOWN) to obtain actual measured value with level in tank or a fix target, i.e. wall. ("GET LEVEL" functions only if ECHO LED is lit) and save it as above.</p> <p>DEFAULT: max. level = max. measuring distance – dead band [m] (100%, Full tank) (See Technical Data Table)</p>
	<p>Error indication by the current output – select "Hold", 3.6" mA or 22" mA (by UP / DOWN key) and save it as above.</p> <p>DEFAULT: hold last value</p>
	<p>Damping Time: select required damping time (by UP / DOWN key) and save it as above.</p> <p>DEFAULT: 300 sec for solids</p>
	<p>Relay Energized xxxx: level of the relay energized state</p> <p>If the value exceeds this programmed value the relay will be energized</p>
	<p>Relay De-energized xxxx: level of the relay de-energized state</p> <p>If the value sinks below this programmed value the relay will be de-energized</p>

Note: Current output can also be programmed for inverted operation: 4 mA= 100% (Full), 20 mA= 0% (Empty)

FULL PARAMETER ACCESS

KEYS	FUNCTION
ENTER E + UP (press for 3 seconds)	Enter or exit Current Output Scaling programming mode

In this programming mode, the display will indicate:

- yy is the Parameter Address
- xxxx is the Parameter Value

Note: Measuring is going on during programming in accordance with the old parameter set. New parameter set will be valid after returning to measurement from programming mode. Steps and indications of the Full Parameter Access programming mode.

KEYS	FUNCTION
ENTER E + UP (press for 3 seconds)	Enter or exit Current Output Scaling programming mode

PRESSING KEYS	WHILE PARAMETER ADDRESS IS BLINKING	WHILE PARAMETER VALUE IS BLINKING
ENTER E	Go to the Parameter Value	Save the modification of the Parameter Value and return to the Parameter Address
NEXT + UP	Cancel all modifications of the actual Programming phase. Pressing for 3 secs is required while CANCEL will be displayed for warning	Neglect the modification of the Parameter Value and return to the Parameter Address without saving the modifications
NEXT + DOWN	Reset entire device to Factory Default. Since this action will reset all parameters, "LOAD" will appear on the display: - to confirm, press ENTER - to escape, press any other key - Exception: clearing TOT 1 (See P77)	Display default of the Parameter Values (it can be saved by pressing ENTER E)
NEXT	Move blinking of the digit to the left	
UP / DOWN	Modify the blinking digit (increase, decrease) or scroll up/down	

MEASUREMENT CONFIGURATION

Application/Engineering Units (P00): Programming of this parameter will result in loading the factory default with the corresponding engineering units.

A	OPERATING (MEASUREMENT) MODE	DISPLAY INDICATION
0	Liquid Level Measurement	"Li"
1	Free Flowing Solids Level Measurement	"So"

B	ENGINEERING UNITS (ACCORDING TO C)	
	METRIC	FEET
0	meter	inch
1	cm	inch

C	CALCULATION SYSTEM	
0	Metric	
1	English	

Factory Default: 0000

MEASUREMENT MODE (P01)

Display, current output and the switching points of the relays will be interpreted in the engineering units of the (measured or calculated) process value corresponding to the programmed measurement mode. On the other hand the higher the “a” of the programmed parameter value the more (measured or calculated) process values can be displayed on the screen. (e.g. if P01 = b0 only the Distance, if P01 = b5 the Distance, the Level, the Volume and the Flow can be displayed. Exception if P01 = b2 or b4.)

A	MEASUREMENT MODE	DISPLAY SYMBOL
0	Distance	DIST
1	Level	LEV
2	Level in percentage	LEV%
3	Volume	VOL
4	Volume in percentage	VOL%
5	Flow	FLOW

B	BARGRAPH INDICATION
0	Echo strength
1	Current output

Factory Default: 11

CALCULATION UNITS (P02)

A	TEMPERATURE
0	° C
1	° F

B	VOLUME		WEIGHT		VOLUME FLOW	
	Metric	US	Metric	US	Metric	US
0	m3	ft3	-	lb (pound)	m3/time	ft3/time
1	Liter	Gallon	Tons	Tons	Liter/time	Liter/time

C	TIME
0	Sec
1	Min
2	Hour
3	Day

Factory Default: 000

VALUES DISPLAYED – ROUNDING (P03)

It is important to keep in mind that the instrument is measuring distance as basic quantity.

The resolution depending on the distance can be considered as a kind of rounding that will be contained in all further value (of level, volume or volume flow) calculated. Therefore, if programmed for DIST or LEV, measurement the setting of P03 is irrelevant.

MEASURED DISTANCE	RESOLUTION
Xmin to 6.6 ft (2 m)	0.04 in. (1 mm)
6.6 ft (2 m) to 16.4 ft (5 m)	0.79 in. (2 mm)
16.4 ft (5 m) to 32.8 ft (10 m)	0.20 in. (5 mm)
Over 32.8 ft (10 m)	0.39 in. (10 mm)

DISPLAYED VOL OR FLOW

Obviously the decimal position will be shifted with increasing value displayed Values over one million will be displayed in exponential format whereas the value (e) represents the exponent. Over the value of 1×10^{10} Err4 (overflow) will be displayed.

DISPLAYED VALUE	DISPLAYED FORM
0.000 – 9.999	x.xxx
10.000 – 99.999	xx.xx
100.000 – 999.999	xxxx.
1000.000 – 9999.999	xxxxx.
100000 – 99999.999	xxxxxx.
1 million – 9.99999×10^9	x.xxxx: e (exponential form)
Over 1×10^{10}	(Overflow) Err4

ROUNDING

A few inches of fluctuation of the basic DIST value (e.g. due to waves) will be enlarged by the mathematical operations. This enlarged fluctuation in displaying VOL or FLOW can (if disturbing) be avoided by rounding to be set in P03. Rounding value 2, 5, 10 etc represents the steps by which the calculated value will be changed in its (one or two) last digit(s).

Examples:

P03=1 steps by 2: 1,000; 1,002; 1,004

P03=5 steps by 50: 1,000; 1,050; 1,100 or 10,00; 10,05(0); 10,10(0); 10,15(0)

(the 0 from the steps 50, 100, 150 etc will not be displayed)

PARAMETER VALUE “A”	STEPS IN THE DISPLAYED VALUE
0	1 no rounding
1	2

Figure 6. Principles of Ultrasonic Level Measurement

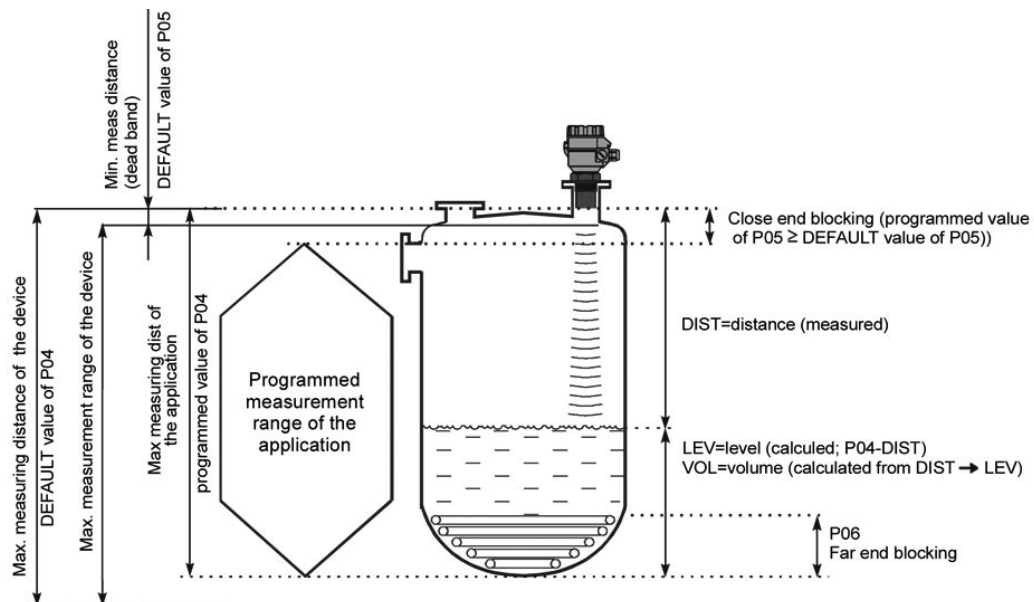

LEVEL

(as the result of the measurement)= $P04$ (programmed)-DISTANCE (measured by the device)

Since the accuracy of level (and all further calculated) value depends on the accuracy of the max measuring distance of the application which is the distance between the sensor face and the tank/silo bottom.

To obtain the best accuracy for a liquid level measurement, measure this distance in the empty tank with the SONO-1000 by using the “GET LEVEL” function (press UP and DOWN keys simultaneously) provided the bottom is flat. Enter the actual measured value displayed as P04.

VALUES OF THE MAXIMUM MEASURING DISTANCE WILL BE IN ACCORDANCE WITH THE TABLE BELOW.

Engineering Unit	Display format
m	x.xxx or xx.xx
cm	xxx.x
ft	xx.xx or xxx.x
inch	xxx.x

MINIMUM MEASURING DISTANCE (CLOSE-END BLOCKING) (P05)

The SONO-1000 will not accept any echo within the blocking distance set here.

- Automatic Close-end-blocking (Automatic Dead Band control)
By using the factory default value, the unit will automatically set the smallest possible close-end blocking distance i.e. the dead band.
- Manual Close-end-blocking
Manual Close-end-blocking would be used for example to block out the echo originating from the bottom rim of a stand-off pipe or from any object protruding into the ultrasonic cone near the transmitter
By entering a value, higher than the factory default, the minimum measuring range will be extended and fixed to the specified value.
To display factory default of the minimum measuring distance, press NEXT + DOWN .

FAR-END BLOCKING

Figure 7. Level Measurement

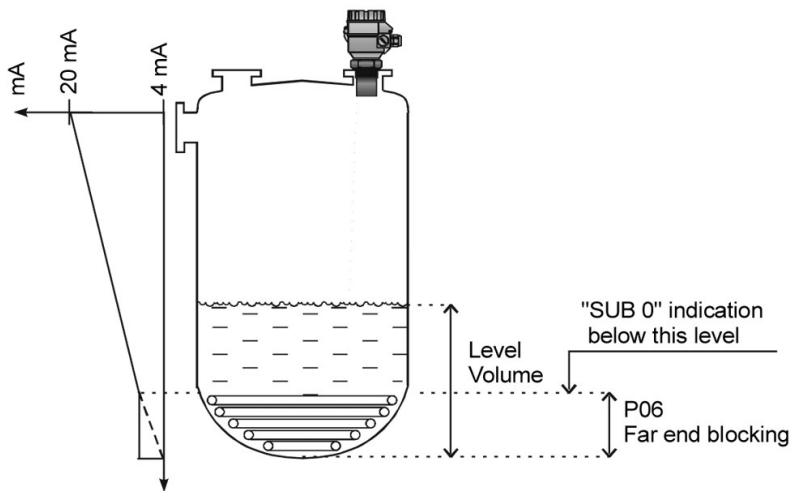

LEVEL MEASUREMENT

Far end blocking is used to neglect incorrect level/volume readings and output actions below a preset level. In the far-end of the measuring range, for example tanks with heaters or other interfering objects (sludge, cone of silo, etc.) may cause fault readings.

If the level of the medium sinks below the blocked out range:

- “Sub 0” will be indicated for the level and volume
- Distance value is not interpretable
- Current output will hold value corresponding to the far end blocking level

If the medium level is above the blocked out range: The calculation of level and volume will be based on the programmed tank dimensions, therefore the measured or calculated process values will not be influenced in any way, by the far end blocking value.

CURRENT OUTPUT

VALUE (OF DISTANCE, LEVEL, VOLUME OR FLOW) ASSIGNED TO 4 MA CURRENT OUTPUT (P10)

VALUE (OF DISTANCE, LEVEL, VOLUME OR FLOW) ASSIGNED TO 20 MA CURRENT OUTPUT (P11)

Values are interpreted according to P01(a). Please note that in case of programming for (LEV or VOL) % measurement the min and max value has to be entered in the relevant engineering units of LEV (m, ft) or VOL (m3, ft3). Assignment can be made so that the proportion between the change of the (measured or calculated) process value and the change of the current output be either direct or inverse. E.g. lev 1m assigned to 4mA and lev 10m assigned to 20mA represents direct proportion and lev 1m assigned to 20mA and lev 10 m assigned to 4mA represents the inverse proportion.

Factory Default:

- P10 0 level (max distance)
- P11 max level (min distance)

ERROR INDICATION BY THE CURRENT OUTPUT (P12)

In case of error the SONO-1000 will provide one of the current outputs below.

A	ERROR INDICATION
0	Hold last value
1	3.6 mA
2	22 mA

Factory Default: 0

RELAY OUTPUT

RELAY OUTPUT (P13)

Relay Function

A	RELAY FUNCTION		ALSO SET:
0	<p>DIFFERENTIAL LEVEL CONTROL</p> <p>(Hysteresis control) Relay is energized if the measured or calculated value exceeds the value set in P14. Relay is de-energized if the measured or calculated value descends under the value set in P15.</p>		<p>P14, P15</p> <p>There is a need to set (in level min 20 mm) hysteresis between P14 and P15</p>
1	Relay is energized in case of echo loss		
2	Relay is de-energized in case of echo loss		

Factory Default: 2

RELAY PARAMETER – SETPOINT VALUE (P14)

Factory Default: 0

RELAY PARAMETER – SETPOINT VALUE (P15)

Factory Default: 0

MEASUREMENT OPTIMIZATION

DAMPING (P20)

Use this parameter to reduce unwanted fluctuation of the display and output.

A	DAMPING TIME (SECONDS)	FREE FLOWING SOLIDS	
		GRANULES > 2-3 MM	POWDERS < 2-3 MM
0	No filter	Recommended for Testing Only	
1	3	Not Applicable	Not Applicable
2	6	Not Applicable	Not Applicable
3	10	Not Applicable	Not Applicable
4	30	Not Applicable	Not Applicable
5	60	Applicable	Applicable
6	100	Recommended	Recommended
7	300	Recommended	Recommended
8	600	Recommended	Recommended
9	1000	Applicable	Applicable

Factory Default: 300 seconds

DOMESTOP TANK COMPENSATION (P22)

To reduce disturbing effect of possible multiple echoes.

A	COMPENSATION	APPLIED
0	OFF	In case the SONO-1000 is mounted not in the center of the top and the top is flat.
1	ON	In case the SONO-1000 is mounted in the center of a tank with dome-shaped top

Factor Default: 0

ANGLE OF REPOSE (P23)

A	ESTIMATED ANGLE OF REPOSE
0	No angle of repose (default)
1	Below 15°
2	Over 15°

The optimal setting of this parameter can be done with the help of checking the echo strength in the read out parameter P72 indicating the echo amplitude in dB.

The ideal setting of P23 is at which the parameter value in P72 becomes the best (nearest “0”).

1. Set P23 for a= 1, confirm it with [E] and switch to Measurement Mode then return to Programming Mode.
2. Observe the change of echo amplitude in P72 and record an average value.
3. Perform the above with the P23 = 2 setting.
4. Finally set P23 with the value of (a) at which the amplitude value in P72 is nearest to 0.

Factory Default: 0

TARGET TRACKING SPEED (P24)

A	TRACKING SPEED	REMARK
0	Standard	For most applications
1	Fast	For fast changing levels
2	Special	Only for special applications (measuring range is reduced to 50% of the nominal value) The measuring window is inactive and the SONO-1000 will respond practically instantly to any target. Recommended for fast target tracking, but usually not applicable for level metering.

Factory Default: 0

SELECTION OF ECHO WITHIN THE MEASURING WINDOW (P25)

A so-called measuring window is formed around the echo signal. The position of this measuring window determines the flight time for calculation of the distance of the target. (The picture below can be seen on the test oscilloscope)

Figure 8. Selection of Echo

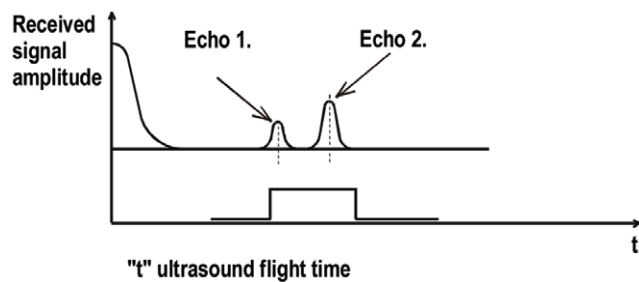

Some applications involve multiple (target + disturbing) echoes even within the measuring window. Basic echo selection will be done by the Quest + software automatically. This parameter only influences the echo selection within the measuring window.

A	ECHO IN WINDOW TO BE SELECTED	REMARK
0	With the highest amplitude	For most applications (both with liquids and solids)
1	First one	For liquids applications with multiple echoes within the Measuring Window
2	Largest one	Recommended for certain free flowing solids applications

Factory Default: 0

(M/H) LEVEL ELEVATION RATE (FILLING SPEED) (P26)

VERY HEAVY FUMING

(M/H) LEVEL DESCENT RATE (EMPTYING SPEED) (P27)

VERY HEAVY FUMING

Use these parameters to provide additional protection against echo loss in applications involving dust during the filling process (powders, dusting granules) or in case of very heavy fuming.

These parameters must not be smaller than the fastest possible filling/emptying rate of the actual technology.

For all other applications, use the factory default setting.

Factory Default: for Solids (P00: So) P27=500

ECHO-LOSS HANDLING (P28)

A	ECHO-LOSS ERROR INDICATION	REMARK
0	Delayed	During echo-loss, display and analogue output will hold last value. If the echo-loss prevails for 10 sec plus the time period set in P20 (damping time), the reading on the display will change to “no Echo” and the outputs will change according to the “Error Indication Mode” preset in P12
1	None	For the time of echo-loss, display and analogue output will hold last value
2	Advance to full	During echo-loss in case of filling, the reading on the display and analogue output will shift towards the “full” tank/silo state with a level elevation rate (filling speed) preset in P26
3	Immediate	In case of echo-loss, the display will immediately change to “no Echo” and the outputs will change according to the “Error Indication Mode” preset in P12
4	No echo-loss indication in case of empty tank/silo	Echo-loss may occur in completely empty tanks with a spherical bottom due to deflection of the ultrasonic beam, or in case of silos with an open outlet. If the echo is lost when the tank/silo is completely empty, the indication will correspond to empty tank, in all other cases echo-loss indication will function according to the “Delayed”.

Factory Default: 0

BLOCKING OUT OF OBJECT #1 (P29)

BLOCKING OUT OF OBJECT #2 (P30)

Up to two fix objects in the tank/silo that disturb the measurement can be blocked out.

Enter the distance of the object from the transducer. Use the Echo Map (P70) to read out the precise distance of disturbing objects.

Factory Default: 0

SOUND VELOCITY AT 20 C (M/SEC OR FT/SEC DEPENDING ON P00(C)) (P31)

Use this parameter if the sound velocity in the gases above the measured surface differs largely from that in air. Recommended for applications where the gas is more or less homogeneous. If it is not, the accuracy of the measurement can be improved using the 32-point linearization (P48, P49).

For sound velocities in various gases see section Sound Velocities.

Factory Default: Metric (P00: “EU”): 343.8 m/s, US (P00: “US”): 1128 ft/s

SPECIFIC GRAVITY (P32)

If you enter value (other than “0”) of specific gravity in this parameter, the weight will be displayed instead of VOL.

Factory Default: 0[kg/dm³] or [lb/ft³] depending on P00(c)

(M) MANUAL ECHO SELECTION BY MOVING THE MEASURING WINDOW (P33)

A so-called measuring window is formed around the echo signal (See scheme on the next page.) The distance of the target will be calculated from the flight time in accordance with the position of the measuring window.

Use this parameter if the SONO-1000 unambiguously selects a wrong echo; for example the echo reflected from the surface is much weaker than the interfering one(s).

Figure 8. Measuring Window

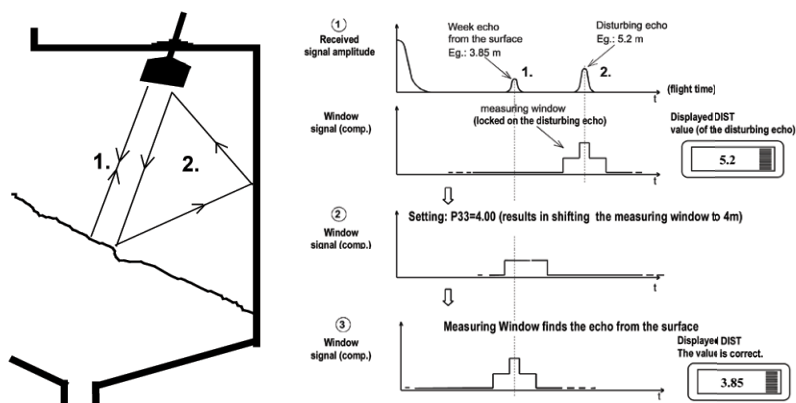

Enter the distance of the correct echo and the software will move the measuring window and calibrate itself to the echo found there.

To determine the distance of the correct echo, either use the Echo Map (to load-in a value from the Echo Map, see parameter P70), or measure the distance with an appropriate device, and enter this value in P33.

If this parameter has been used (P33 is not 0), its value will be continuously updated with the valid echo position. This means, that in case of a power loss, the SONO-1000 will restart the signal processing with the measuring window at the last updated position. To switch-off this function, set P33=0

Factory Default: 0

VOLUME CALCULATION

BA TANK/SILO SHAPE (P40)

BA	TANK/SILO SHAPE	ALSO TO BE SET
b0	Standing cylindrical tank shape: value of "b" as below bottom	P40(b), P41
01	Standing cylindrical tank/silo with conical bottom	P41, P43, P44
02	Standing rectangular tank/silo (with chute)	P41, P42, (P43, P44, P45)
b3	Lying cylindrical tank shape: value of "b" as below bottom	P40(b), P41, P42
04	Spherical tank	P41

Factory Default: 00

TANK/SILO DIMENSIONS (P41-45)

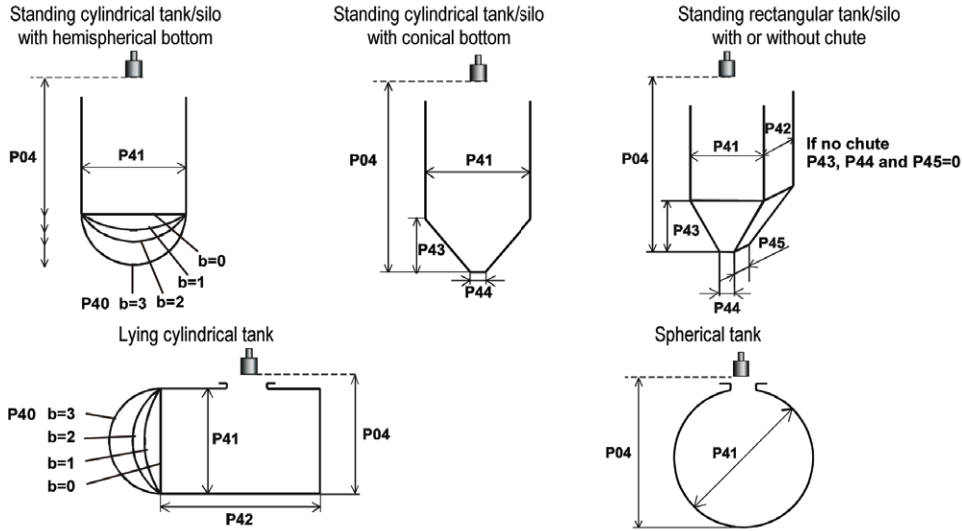

VOLUME FLOW MEASURING

BA, APPLIANCES, FORMULA, DATA (P40)

BA	APPLIANCES, FORMULA, DATA					ALSO TO BE SET:	
	Type	Calculation formula	Qmin [l/m]	Qmax [l/s]	"P" [cm]	P46	
00	Nivelco Parshall flume	GPA-1P1	$Q [l/s]=60.87 \cdot h^{1.552}$	0.26	5.38	30	P46
01		GPA-1P2	$Q [l/s]=119.7 \cdot h^{1.553}$	0.52	13.3	34	P46
02		GPA-1P3	$Q [l/s]=178.4 \cdot h^{1.555}$	0.78	49	39	P46
03		GPA-1P4	$Q [l/s]=353.9 \cdot h^{1.558}$	1.52	164	53	P46
04		GPA-1P5	$Q [l/s]=521.4 \cdot h^{1.558}$	2.25	360	75	P46
05		GPA-1P6	$Q [l/s]=674.6 \cdot h^{1.556}$	2.91	570	120	P46
06		GPA-1P7	$Q [l/s]=1014.9 \cdot h^{1.556}$	4.4	890	130	P46
07		GPA-1P8	$Q [l/s]=1368 \cdot h^{1.5638}$	5.8	1208	135	P46
08		GPA-1P9	$Q [l/s]=2080.5 \cdot h^{1.5689}$	8.7	1850	150	P46
09	General PARSHALL flume					P46, P42	
10	PALMER-BOWLUS (D/2)					P46, P41	
11	PALMER-BOWLUS (D/3)					P46, P41	
12	PALMER-BOWLUS (Rectangular)					P46, P41, P42	
13	Khafagi Venturi					P46, P42	
14	Bottom-step weir					P46, P42	
15	Suppressed rectangular or BAZIN weir					P46, P41, P42	
16	Trapezoidal weir					P46, P41, P42	
17	Special trapezoidal (4:1) weir					P46, P42	
18	V-notch weir					P46, P42	
19	THOMSON (90°-notch) weir					P46	
20	Circular weir					P46, P41	
21	General flow formula: $Q [l/s]=1000 \cdot P41 \cdot h^{P42}$, h[m]					P46, P41, P42	

FLUME/WEIR DIMENSIONS (P41-45)

Factory Default: 0

32-POINT LINEARISATION CURVE

A LINEARISATION (P47)

A	LINEARISATION
0	OFF (Factory Default)
1	ON

LINEARISATION TABLE (P48)

Linearisation is the method of assigning requested (calibrated or calculated) level, volume or flow to values measured by the transmitter. It

It can be used for instance if the sound velocity is not known (LEVEL LEVEL) or in the case of vertical cylindrical tank (LEVEL VOLUME) etc.

Data-pairs of the linearisation table are handled in 2X32 matrix, consisting of two columns.

LEFT COLUMN "L"	RIGHT COLUMN "R"
LEVEL measured	LEVEL or VOLUME or FLOW to be transmitted and displayed

The left column values (indicated on the display as "L") contain the measured LEVEL values.

The right column values (indicated on the display as "r") contain the calibrated values and are interpreted according to the selected measurement value in P01(a).

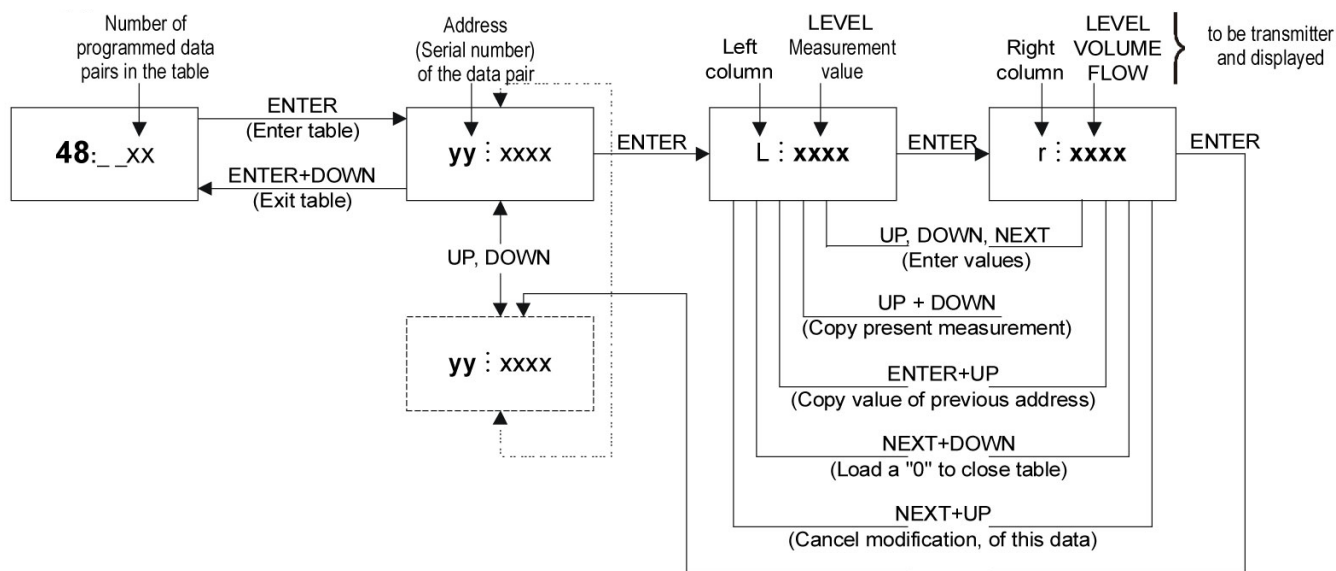

LEFT COLUMN "L"	RIGHT COLUMN "R"
L(1)=0	r(1)
L(i)	r(i)
:	:
L(i)	r(i)

- The table must always start with: L(1)=0 and r(1)=value (assigned to 0 level)
- The table must be ended either with the 32. data pair i.e. j=32
- Or if the linearization table contains less than 32 data-pairs j<32, the table must be closed by a level value “0” e.g. L(j<32)=0
- The SONO-1000 will ignore data after recognising level value “0” with serial number other than “1”.
- If the above data conditions are not met, error codes will be displayed (see chapter: Error Codes).

INFORMATIONAL PARAMETERS

(H) OVERALL OPERATING HOURS OF THE UNIT (P60)

Indication varies according to the elapsed time:

OPERATING HOURS	INDICATION FORM
0 to 999.9h	xxx.x
1000 to 9999h	xxxx
Over 9999h	X,xx: e meaning x,xx 10e

(H) TIME ELAPSED AFTER LAST SWITCH-ON (P61)

(H) OPERATING HOURS OF THE RELAY (P62)

NUMBER OF SWITCHING CYCLE OF THE RELAY (P63)

Indication same as in P60

(°C/°F) ACTUAL TEMPERATURE OF THE TRANSDUCER (P64)

(°C/°F) MAXIMUM TEMPERATURE OF THE TRANSDUCER (P65)

(°C/°F) MINIMUM TEMPERATURE OF THE TRANSDUCER (P66)

In case of a breaking in the temperature measuring Pt10 element, PtErr” will be displayed. The transmitter will perform temperature correction corresponding to 68°F (20°C).

NUMBER OF ECHOES/ECHO MAP (P70)

Viewing this parameter gives the number of echoes detected by the system. Entering this parameter will save the actual echo map, and the distance and amplitude of these echoes can be read-out one by one.

To move the Measuring Window manually to one of the echoes displayed in the Echo Map:

- 1) Select an echo in the Echo Map (display should indicate the distance of the selected echo)
- 2) Press the UP + DOWN keys simultaneously (display will indicate “Set 33”)
- 3) The selected echo is loaded into the P33 parameter (see P33)

DISTANCE OF THE MEASURING WINDOW (READ-OUT PARAMETER) (P71)

AMPLITUDE OF THE ECHO IN THE MEASURING (READ-OUT PARAMETER) (P72)

(MSEC) ECHO POSITION (TIME) (READ OUT PARAMETER) (P73)

SIGNAL TO NOISE RATIO (READ OUT PARAMETER) (P74)

RATIO	MEASUREMENT CONDITIONS
Over 70	Excellent
Between 70 and 30	Good
Under 30	Unreliable

BLOCKING DISTANCE (P75)



The actual close-end blocking distance is displayed. Provides useful information if automatic blocking was selected in P05.

TEST PARAMETERS

(MA) CURRENT OUTPUT TEST (P80)

Entering this parameter will result in displaying the actual current output. Set any value between 3,8 and 20,5 and Press E. Check current output by amp. meter. It has to show the same value set previously. Return to the parameter address by pressing ENTER E.

A RELAY TEST (P81)

The actual state of the relay can be seen on the display (code according to the table below and symbol on the screen. Test the relay by pressing UP  and DOWN  while observing change of the symbol and the code or listening to the ticking of the relay or checking on-off resistance by a suitable resistance meter.

A	RELAY STATE
0	De-energised
1	Energised

SIMULATION MODE

This function enables the user to test the settings of the outputs. The Sono-1000 can simulate a static or continuous change of level, according to the preset simulation parameters.

Set the required simulation by programming P84, P85, P86 and P87.

X SIMULATION MODE (P84)

X	SIMULATION TYPE
0	No simulation (FACTORY DEFAULT)
1	The level changes continuously up and down between the level values set in P86 and P87 with a cycle time set in P85
2	Static level simulation: the level will be the value set in P86

The simulation levels must be within the programmed measuring range: P04 and P05

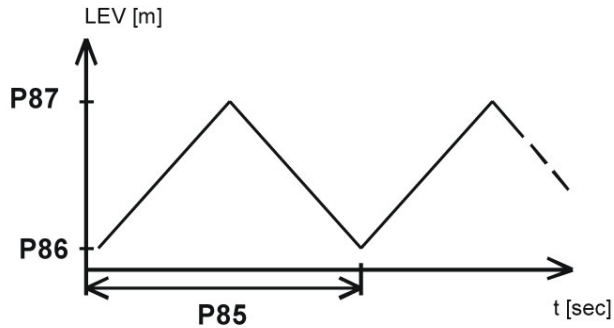

SEC) CYCLE TIME FOR SIMULATION (P85)

(M) SIMULATED LOW LEVEL VALUE (P86)

(M) SIMULATED HIGH LEVEL VALUE (P87)

To start the simulation mode, return to the measurement mode. While the SONO-1000 is in simulation mode the DIST, LEV, or VOL symbol will be blinking.

To quit the simulation mode, set P84=0.

ACCESS LOCK

DCBA ACCESS LOCK BY SECRET CODE (P99)

The purpose of this feature is to provide protection against accidental (or intentional) re-programming of parameters.

The secret Code can be a numeric value other than 0000. Setting a Secret Code will automatically be activated when the EchoTREK is returned to the Measurement Mode. If the Secret Code is activated, the parameters can only be viewed, this is indicated by the flashing colon ":" between the parameter address and the parameter value.

In order to program the device locked by a secret code, first enter the Secret Code in P99. The Secret Code is re-activated each time the EchoTREK is returned to Measurement Mode.

To delete the Secret Code, enter the Secret Code in P99. After confirming it with [E] re-enter the parameter P99 and enter 0000.

[dcba (Secret Code)] [E] [E] [0000] [E] Secret

PARAMETR TABLE

PARAMETER	DESCRIPTION	DEFAULT	CURRENT
P00	Application/Engineering Units	000	
P01	Measurement Mode	11	
P02	Calculation Units	000	
P03	Values Displayed-Rounding	0	
P04	Maximum Measuring Distance	Automatic	
P05	Minimum Measuring Distance	2	
P06	Far-End Blocking	0	
P08	NA	0	
P10	Assigned 4 mA Value	0	
P11	Assigned 20 mA Value	Max Level	
P12	Error Indication by the Current Output	0	
P13	Relay Function	2	
P14	Relay Parameter Setpoint Value	0	
P15	Relay Parameter Setpoint Value	0	
P19	NA	0000	
P20	Damping	7	
P21	NA	3700	
P22	Dome Top Tank Compensation	0	
P23	Angle of Repose	0	
P24	Target Tracking Speed	0	
P25	Selection of Echo in the Measuring Window	0	
P26	Level Elevation Rate(Filling Speed)	500	
P27	Level Descent Rate (Emptying Speed)	500	
P28	Echo Loss Handling	0	
P29	Blocking Out of Object #1	0	
P30	Blocking Out of Object #2	0	
P31	Sound Velocity at 20 C	1128	
P32	Specific Gravity	0	
P33	Manual Echo Selection	0	
P40	Tank/Silo Shape/Appliances, Formula, Data	0	
P41	NA	0	
P42	NA	0	
P43	NA	0	
P44	NA	0	
P45	NA	0	
P47	Linearization	0	
P48	Linearization Table	0	
P60	Total Operating Hours of Unit		Read Out
P61	Time Elapsed After Last Switch-On		Read Out
P62	Operating Hours of the Relay		Read Out
P63	Number of Switching Cycle of the Relay		Read Out
P64	Actual Temperature of the Transducer		Read Out
P65	Maximum Temperature of the Transducer		Read Out
P66	Minimum Temperature of the Transducer		Read Out
P70	Number of Echoes / Echo Map		Read Out
P71	Distance of the Measuring Window		Read Out

P72	Amplitude of the Echo in the Measuring Window		Read Out
P73	Echo Position (time)		Read Out
P74	Signal to Noise Ratio		Read Out
P75	Blocking Distance		Read Out
P80	Current Output Test		Input Test Value
P81	Relay Test		Input Test Value
P82	NA	03	
P84	Simulation Mode	0	
P85	Cycle Time for Simulation		Input Test Value
P86	Simulated Low Level Value		Input Test Value
P87	Simulated High Level Value		Input Test Value
P96	NA	19	
P97	Software Code	1.61	
P98	NA	3612	
P99	Access Lock By Secret Code	0000	

VII. MAINTENANCE

PREVENTATIVE MAINTENANCE

The device does not require routine maintenance. In case dust adheres to the face of the sensor despite the self-cleaning of the sensor face through resonance, (ex.: static build-up) it can be cleaned by using pressurised air.

VIII. TROUBLESHOOTING

Contact your local representative for additional assistance. Please provide the following information:

- Model number
- Date of Purchase
- Application information (type of material, mounting configuration, etc.)
- Description of problem

ERROR CODE	ERROR DESCRIPTION	CAUSES AND ACTIONS TO BE DONE
1	Memory error	Contact local agent
No Echo or 2	Echo loss	No echo received (no reflection)
3	Hardware error	Contact local agent
4	Overflow	Check settings
5	Code referring to sensor error or improper installation/mounting, level in the dead band	Verify sensor for correct operation and check for correct mounting according to Users Manual
6	The measurement is at the reliability threshold (only for free flowing solids level measurement)	Re-aim the sensor or try to find a better location
7	No signal received within the measuring range specified in P04 and P05.	Review programming, also look for installation mistake
12	Linearization table error: L(1) and L(2) are both zero (no valid data-pairs)	See the Section "Linearization"
13	Linearization table error: there are two same L(i) data in the table	See the Section "Linearization"
14	Linearisation table error: the r(i) values are not monotone increasing	See the Section "Linearization"
15	Linearisation table error: measured Level is higher than the last Volume or Flow data-pair	See the Section "Linearization"
16	The checksum of the program in the EEPROM is wrong	Contact local agent
PtErr	Break in the temperature sensor circuit	Contact local agent

IX. DIMENSIONAL DRAWINGS

FIGURE 1: Dimension Drawing With Ball-Joint Housing

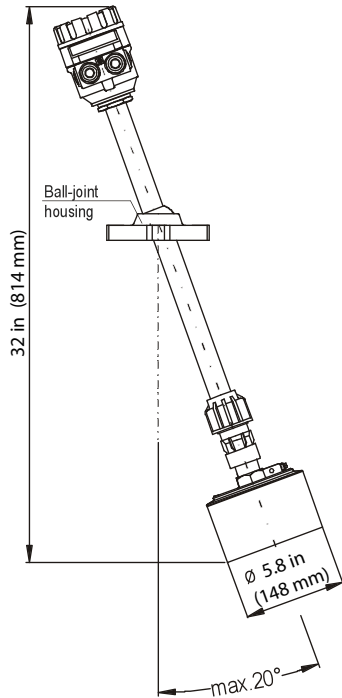

FIGURE 2: 8 IN FF FLANGE, DRILLED LIKE 150 PSI FLANGE

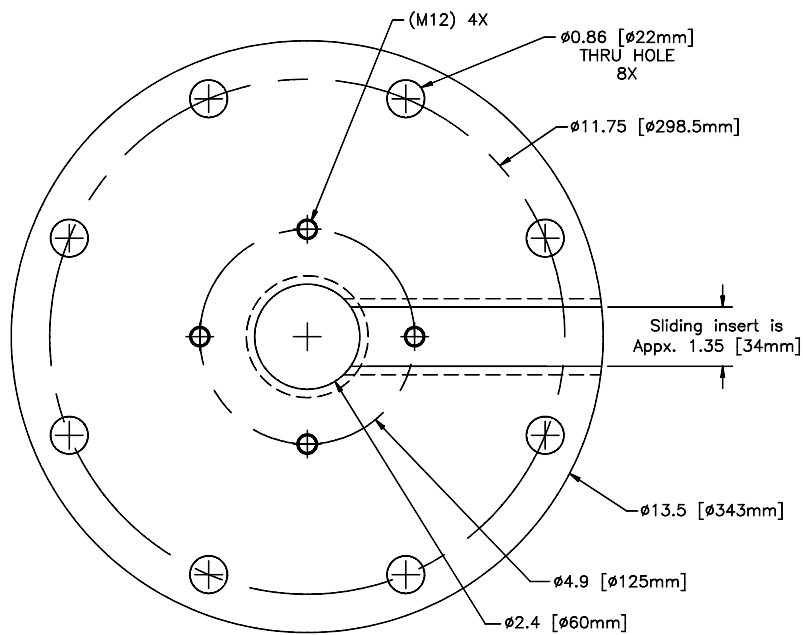
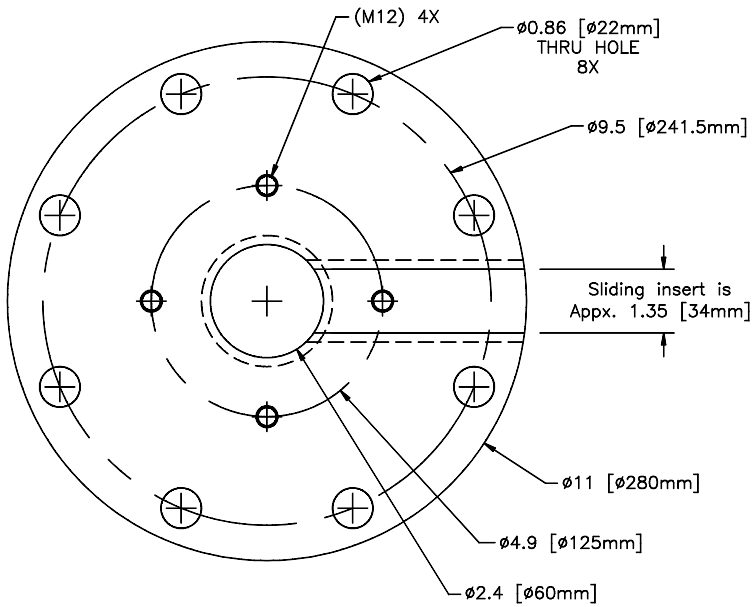

FIGURE 3: 6 IN FF FLANGE, DRILLED LIKE 150 PSI FLANGE



X. WARRANTY

A manufacturer's limited equipment warranty applies. Please consult the terms and conditions provided at the point of sale for a full description of the manufacturer's warranty. For a generic version of the warranty please consult the manufacturer.

Notes



150 Venture Boulevard
Spartanburg, SC 29306
Tel: (800) 778-9242
Fax: (864) 574-8063
sales@bindicator.com
www.bindicator.com

venture
MEASUREMENT

2013 All rights reserved.
All data subject to change without notice.

SON180212 Rev. D